

Programmable Controller

MELSEC iQ-R
series

MELSEC iQ-R Digital-Analog Converter Module User's Manual (Application)

-R60DA4
-R60DAV8
-R60DAI8



SAFETY PRECAUTIONS

(Read these precautions before using this product.)

Before using this product, please read this manual and the relevant manuals carefully and pay full attention to safety to handle the product correctly.

The precautions given in this manual are concerned with this product only. For the safety precautions of the programmable controller system, refer to the MELSEC iQ-R Module Configuration Manual.

In this manual, the safety precautions are classified into two levels: "⚠ WARNING" and "⚠ CAUTION".

 WARNING	Indicates that incorrect handling may cause hazardous conditions, resulting in death or severe injury.
 CAUTION	Indicates that incorrect handling may cause hazardous conditions, resulting in minor or moderate injury or property damage.

Under some circumstances, failure to observe the precautions given under "⚠ CAUTION" may lead to serious consequences.

Observe the precautions of both levels because they are important for personal and system safety.

Make sure that the end users read this manual and then keep the manual in a safe place for future reference.

[Design Precautions]

WARNING

- Configure safety circuits external to the programmable controller to ensure that the entire system operates safely even when a fault occurs in the external power supply or the programmable controller. Failure to do so may result in an accident due to an incorrect output or malfunction.
 - (1) Emergency stop circuits, protection circuits, and protective interlock circuits for conflicting operations (such as forward/reverse rotations or upper/lower limit positioning) must be configured external to the programmable controller.
 - (2) When the programmable controller detects an abnormal condition, it stops the operation and all outputs are:
 - Turned off if the overcurrent or overvoltage protection of the power supply module is activated.
 - Held or turned off according to the parameter setting if the self-diagnostic function of the CPU module detects an error such as a watchdog timer error.
 - (3) All outputs may be turned on if an error occurs in a part, such as an I/O control part, where the CPU module cannot detect any error. To ensure safety operation in such a case, provide a safety mechanism or a fail-safe circuit external to the programmable controller. For a fail-safe circuit example, refer to "General Safety Requirements" in the MELSEC iQ-R Module Configuration Manual.
 - (4) Outputs may remain on or off due to a failure of a component such as a relay and transistor in an output circuit. Configure an external circuit for monitoring output signals that could cause a serious accident.
 - In an output circuit, when a load current exceeding the rated current or an overcurrent caused by a load short-circuit flows for a long time, it may cause smoke and fire. To prevent this, configure an external safety circuit, such as a fuse.
 - Configure a circuit so that the programmable controller is turned on first and then the external power supply. If the external power supply is turned on first, an accident may occur due to an incorrect output or malfunction.
 - For the operating status of each station after a communication failure, refer to manuals relevant to the network. Incorrect output or malfunction due to a communication failure may result in an accident.
 - When connecting an external device with a CPU module or intelligent function module to modify data of a running programmable controller, configure an interlock circuit in the program to ensure that the entire system will always operate safely. For other forms of control (such as program modification, parameter change, forced output, or operating status change) of a running programmable controller, read the relevant manuals carefully and ensure that the operation is safe before proceeding. Improper operation may damage machines or cause accidents.
 - Especially, when a remote programmable controller is controlled by an external device, immediate action cannot be taken if a problem occurs in the programmable controller due to a communication failure. To prevent this, configure an interlock circuit in the program, and determine corrective actions to be taken between the external device and CPU module in case of a communication failure.
 - Do not write any data to the "system area" and "write-protect area" of the buffer memory in the module. Also, do not use any "use prohibited" signals as an output signal from the CPU module to each module. Doing so may cause malfunction of the programmable controller system. For the "system area", "write-protect area", and the "use prohibited" signals, refer to the user's manual for the module used.
-

[Design Precautions]

WARNING

- If a communication cable is disconnected, the network may be unstable, resulting in a communication failure of multiple stations. Configure an interlock circuit in the program to ensure that the entire system will always operate safely even if communications fail. Incorrect output or malfunction due to a communication failure may result in an accident.
 - To maintain the safety of the programmable controller system against unauthorized access from external devices via the network, take appropriate measures. To maintain the safety against unauthorized access via the Internet, take measures such as installing a firewall.
 - Analog outputs may remain on due to a failure of the module. Configure an external interlock circuit for output signals that could cause a serious accident.
-

[Design Precautions]

CAUTION

- Do not install the control lines or communication cables together with the main circuit lines or power cables. Keep a distance of 100mm or more between them. Failure to do so may result in malfunction due to noise.
 - During control of an inductive load such as a lamp, heater, or solenoid valve, a large current (approximately ten times greater than normal) may flow when the output is turned from off to on. Therefore, use a module that has a sufficient current rating.
 - After the CPU module is powered on or is reset, the time taken to enter the RUN status varies depending on the system configuration, parameter settings, and/or program size. Design circuits so that the entire system will always operate safely, regardless of the time.
 - Do not power off the programmable controller or reset the CPU module while the setting values in the buffer memory are being written to the flash ROM in the module. Doing so will make the data in the flash ROM undefined. The values need to be set in the buffer memory and written to the flash ROM again. Doing so also can cause malfunction or failure of the module.
 - When changing the operating status of the CPU module (such as remote RUN/STOP) from the external device, select "Do Not OPEN in Program" for the "Open Method Setting" in the module parameter. The communication line will be closed when "OPEN in Program" is selected and the remote STOP is executed from the external device. Consequently, the CPU module cannot reopen the communication line, and the external device cannot execute the remote RUN.
 - Power on or off the external power supply while the programmable controller is on. Failure to do so may result in incorrect output or malfunction.
 - At on/off of the power or external power supply, or at the output range switching, a voltage may occur or a current may flow between output terminals for a moment. In this case, start the control after analog outputs become stable.
-

[Installation Precautions]

WARNING

- Shut off the external power supply (all phases) used in the system before mounting or removing the module. Failure to do so may result in electric shock or cause the module to fail or malfunction.
-

[Installation Precautions]

CAUTION

- Use the programmable controller in an environment that meets the general specifications in the Safety Guidelines included with the base unit. Failure to do so may result in electric shock, fire, malfunction, or damage to or deterioration of the product.
 - To mount a module, place the concave part(s) located at the bottom onto the guide(s) of the base unit, and push in the module until the hook(s) located at the top snaps into place. Incorrect interconnection may cause malfunction, failure, or drop of the module.
 - When using the programmable controller in an environment of frequent vibrations, fix the module with a screw.
 - Tighten the screws within the specified torque range. Undertightening can cause drop of the screw, short circuit, or malfunction. Overtightening can damage the screw and/or module, resulting in drop, short circuit, or malfunction.
 - When using an extension cable, connect it to the extension cable connector of the base unit securely. Check the connection for looseness. Poor contact may cause malfunction.
 - When using an SD memory card, fully insert it into the SD memory card slot. Check that it is inserted completely. Poor contact may cause malfunction. / Failure to do so may cause malfunction.
 - Securely insert an extended SRAM cassette into the cassette connector of the CPU module. After insertion, close the cassette cover and check that the cassette is inserted completely. Poor contact may cause malfunction.
 - Do not directly touch any conductive parts and electronic components of the module, SD memory card, extended SRAM cassette, or connector. Doing so can cause malfunction or failure of the module.
-

[Wiring Precautions]

WARNING

- Shut off the external power supply (all phases) used in the system before installation or wiring. Failure to do so may result in electric shock or cause the module to fail or malfunction.
 - After installation and wiring, attach the included terminal cover to the module before turning it on for operation. Failure to do so may result in electric shock.
-

[Wiring Precautions]

CAUTION

- Individually ground the FG and LG terminals of the programmable controller with a ground resistance of 100 ohms or less. Failure to do so may result in electric shock or malfunction.
 - Use applicable solderless terminals and tighten them within the specified torque range. If any spade solderless terminal is used, it may be disconnected when the terminal screw comes loose, resulting in failure.
 - Check the rated voltage and signal layout before wiring to the module, and connect the cables correctly. Connecting a power supply with a different voltage rating or incorrect wiring may cause fire or failure.
 - Connectors for external devices must be crimped or pressed with the tool specified by the manufacturer, or must be correctly soldered. Incomplete connections may cause short circuit, fire, or malfunction.
 - Securely connect the connector to the module. Poor contact may cause malfunction.
 - Do not install the control lines or communication cables together with the main circuit lines or power cables. Keep a distance of 100mm or more between them. Failure to do so may result in malfunction due to noise.
 - Place the cables in a duct or clamp them. If not, dangling cable may swing or inadvertently be pulled, resulting in damage to the module or cables or malfunction due to poor contact. Do not clamp the extension cables with the jacket stripped. Doing so may change the characteristics of the cables, resulting in malfunction.
 - Check the interface type and correctly connect the cable. Incorrect wiring (connecting the cable to an incorrect interface) may cause failure of the module and external device.
 - Tighten the terminal screws or connector screws within the specified torque range. Undertightening can cause drop of the screw, short circuit, fire, or malfunction. Overtightening can damage the screw and/or module, resulting in drop, short circuit, fire, or malfunction.
 - When disconnecting the cable from the module, do not pull the cable by the cable part. For the cable with connector, hold the connector part of the cable. For the cable connected to the terminal block, loosen the terminal screw. Pulling the cable connected to the module may result in malfunction or damage to the module or cable.
 - Prevent foreign matter such as dust or wire chips from entering the module. Such foreign matter can cause a fire, failure, or malfunction.
 - A protective film is attached to the top of the module to prevent foreign matter, such as wire chips, from entering the module during wiring. Do not remove the film during wiring. Remove it for heat dissipation before system operation.
 - Mitsubishi programmable controllers must be installed in control panels. Connect the main power supply to the power supply module in the control panel through a relay terminal block. Wiring and replacement of a power supply module must be performed by qualified maintenance personnel with knowledge of protection against electric shock. For wiring, refer to the MELSEC iQ-R Module Configuration Manual.
 - For Ethernet cables to be used in the system, select the ones that meet the specifications in the user's manual for each module. If not, normal data transmission is not guaranteed.
-

[Startup and Maintenance Precautions]

Warning

- Do not touch any terminal while power is on. Doing so will cause electric shock or malfunction.
 - Correctly connect the battery connector. Do not charge, disassemble, heat, short-circuit, solder, or throw the battery into the fire. Also, do not expose it to liquid or strong shock. Doing so will cause the battery to produce heat, explode, ignite, or leak, resulting in injury and fire.
 - Shut off the external power supply (all phases) used in the system before cleaning the module or retightening the terminal screws, connector screws, or module fixing screws. Failure to do so may result in electric shock.
-

[Startup and Maintenance Precautions]

CAUTION

- When connecting an external device with a CPU module or intelligent function module to modify data of a running programmable controller, configure an interlock circuit in the program to ensure that the entire system will always operate safely. For other forms of control (such as program modification, parameter change, forced output, or operating status change) of a running programmable controller, read the relevant manuals carefully and ensure that the operation is safe before proceeding. Improper operation may damage machines or cause accidents.
 - Especially, when a remote programmable controller is controlled by an external device, immediate action cannot be taken if a problem occurs in the programmable controller due to a communication failure. To prevent this, configure an interlock circuit in the program, and determine corrective actions to be taken between the external device and CPU module in case of a communication failure.
 - Do not disassemble or modify the modules. Doing so may cause failure, malfunction, injury, or a fire.
 - Use any radio communication device such as a cellular phone or PHS (Personal Handy-phone System) more than 25cm away in all directions from the programmable controller. Failure to do so may cause malfunction.
 - Shut off the external power supply (all phases) used in the system before mounting or removing the module. Failure to do so may cause the module to fail or malfunction.
 - Tighten the screws within the specified torque range. Undertightening can cause drop of the component or wire, short circuit, or malfunction. Overtightening can damage the screw and/or module, resulting in drop, short circuit, or malfunction.
 - After the first use of the product, do not mount/remove the module to/from the base unit, and the terminal block to/from the module, and do not insert/remove the extended SRAM cassette to/from the CPU module more than 50 times (IEC 61131-2 compliant) respectively. Exceeding the limit may cause malfunction.
 - After the first use of the product, do not insert/remove the SD memory card to/from the CPU module more than 500 times. Exceeding the limit may cause malfunction.
 - Do not touch the metal terminals on the back side of the SD memory card. Doing so may cause malfunction.
 - Do not touch the integrated circuits on the circuit board of an extended SRAM cassette. Doing so may cause malfunction.
 - Do not drop or apply shock to the battery to be installed in the module. Doing so may damage the battery, causing the battery fluid to leak inside the battery. If the battery is dropped or any shock is applied to it, dispose of it without using.
 - Startup and maintenance of a control panel must be performed by qualified maintenance personnel with knowledge of protection against electric shock. Lock the control panel so that only qualified maintenance personnel can operate it.
 - Before handling the module, touch a conducting object such as a grounded metal to discharge the static electricity from the human body. Failure to do so may cause the module to fail or malfunction.
-

[Operating Precautions]

CAUTION

- When changing data and operating status, and modifying program of the running programmable controller from an external device such as a personal computer connected to an intelligent function module, read relevant manuals carefully and ensure the safety before operation. Incorrect change or modification may cause system malfunction, damage to the machines, or accidents.
 - Do not power off the programmable controller or reset the CPU module while the setting values in the buffer memory are being written to the flash ROM in the module. Doing so will make the data in the flash ROM undefined. The values need to be set in the buffer memory and written to the flash ROM again. Doing so also can cause malfunction or failure of the module.
-

[Disposal Precautions]

CAUTION

- When disposing of this product, treat it as industrial waste.
 - When disposing of batteries, separate them from other wastes according to the local regulations. For details on battery regulations in EU member states, refer to the MELSEC iQ-R Module Configuration Manual.
-

[Transportation Precautions]

CAUTION

- When transporting lithium batteries, follow the transportation regulations. For details on the regulated models, refer to the MELSEC iQ-R Module Configuration Manual.
 - The halogens (such as fluorine, chlorine, bromine, and iodine), which are contained in a fumigant used for disinfection and pest control of wood packaging materials, may cause failure of the product. Prevent the entry of fumigant residues into the product or consider other methods (such as heat treatment) instead of fumigation. The disinfection and pest control measures must be applied to unprocessed raw wood.
-

CONDITIONS OF USE FOR THE PRODUCT

(1) Mitsubishi programmable controller ("the PRODUCT") shall be used in conditions;

- i) where any problem, fault or failure occurring in the PRODUCT, if any, shall not lead to any major or serious accident; and
- ii) where the backup and fail-safe function are systematically or automatically provided outside of the PRODUCT for the case of any problem, fault or failure occurring in the PRODUCT.

(2) The PRODUCT has been designed and manufactured for the purpose of being used in general industries.

MITSUBISHI SHALL HAVE NO RESPONSIBILITY OR LIABILITY (INCLUDING, BUT NOT LIMITED TO ANY AND ALL RESPONSIBILITY OR LIABILITY BASED ON CONTRACT, WARRANTY, TORT, PRODUCT LIABILITY) FOR ANY INJURY OR DEATH TO PERSONS OR LOSS OR DAMAGE TO PROPERTY CAUSED BY the PRODUCT THAT ARE OPERATED OR USED IN APPLICATION NOT INTENDED OR EXCLUDED BY INSTRUCTIONS, PRECAUTIONS, OR WARNING CONTAINED IN MITSUBISHI'S USER, INSTRUCTION AND/OR SAFETY MANUALS, TECHNICAL BULLETINS AND GUIDELINES FOR the PRODUCT.

("Prohibited Application")

Prohibited Applications include, but not limited to, the use of the PRODUCT in;

- Nuclear Power Plants and any other power plants operated by Power companies, and/or any other cases in which the public could be affected if any problem or fault occurs in the PRODUCT.
- Railway companies or Public service purposes, and/or any other cases in which establishment of a special quality assurance system is required by the Purchaser or End User.
- Aircraft or Aerospace, Medical applications, Train equipment, transport equipment such as Elevator and Escalator, Incineration and Fuel devices, Vehicles, Manned transportation, Equipment for Recreation and Amusement, and Safety devices, handling of Nuclear or Hazardous Materials or Chemicals, Mining and Drilling, and/or other applications where there is a significant risk of injury to the public or property.

Notwithstanding the above restrictions, Mitsubishi may in its sole discretion, authorize use of the PRODUCT in one or more of the Prohibited Applications, provided that the usage of the PRODUCT is limited only for the specific applications agreed to by Mitsubishi and provided further that no special quality assurance or fail-safe, redundant or other safety features which exceed the general specifications of the PRODUCTS are required. For details, please contact the Mitsubishi representative in your region.

INTRODUCTION

Thank you for purchasing the Mitsubishi Electric MELSEC iQ-R series programmable controllers.

This manual describes the functions, parameter settings, and troubleshooting of the relevant products listed below.

Before using this product, please read this manual and the relevant manuals carefully and develop familiarity with the functions and performance of the MELSEC iQ-R series programmable controller to handle the product correctly.

When applying the program examples provided in this manual to an actual system, ensure the applicability and confirm that it will not cause system control problems.

Please make sure that the end users read this manual.

Point

Unless otherwise specified, this manual describes the program examples in which the I/O numbers of X/Y0 to X/YF are assigned for a D/A converter module. I/O numbers must be assigned to apply the program examples introduced in this manual to an actual system. For I/O number assignment, refer to the following.

 MELSEC iQ-R CPU Module User's Manual (Application)

Relevant products

R60DA4, R60DAV8, R60DAI8

MEMO

CONTENTS

SAFETY PRECAUTIONS	1
CONDITIONS OF USE FOR THE PRODUCT	9
INTRODUCTION	10
RELEVANT MANUALS	14
TERMS	14
CHAPTER 1 FUNCTIONS	15
1.1 Modes	16
1.2 Range Switching Function	18
1.3 D/A Conversion Enable/Disable Function	19
1.4 D/A Output Enable/Disable Setting Function	19
1.5 Analog Output HOLD/CLEAR Function	20
1.6 Analog Output Test when CPU Module is in STOP Status Function	22
1.7 Scaling Function	23
1.8 Shift Function	26
1.9 Alert Output Function	28
1.10 Rate Control Function	30
1.11 External Power Supply Disconnection Detection Function	33
1.12 Disconnection Detection Function	34
1.13 Interrupt Function	35
1.14 Wave Output Function	38
Initial settings of the wave output function	46
Execution of the wave output function	52
Points to use the wave output function	64
Wave output step action function	70
1.15 Inter-Module Synchronization Function	78
1.16 Error History Function	84
1.17 Event History Function	87
1.18 Backing up, Saving, and Restoring Offset/Gain Values	88
When a module-specific backup parameters is used	88
When the module-specific backup parameter is not used	90
1.19 Q Compatible Mode Function	94
CHAPTER 2 PARAMETER SETTING	95
2.1 Basic Setting	95
2.2 Application Setting	96
2.3 Interrupt Setting	97
2.4 Refresh Settings	98
Refresh processing time	99
CHAPTER 3 TROUBLESHOOTING	100
3.1 Checking Using LEDs	100
3.2 Checking the Status of the Module	101
3.3 Troubleshooting by Symptom	102
When the RUN LED flashes or turns off	102
When the ERR LED turns on	102
When the ALM LED turns on	102
When an analog value is not output	103

When an analog value is not output with the wave output function being selected	104
When HOLD of analog output value is not available	104
When the synchronization output is not performed	105
When 'External power supply READY flag' (X7) does not turn on	105
3.4 Error Code List	106
3.5 Alarm Code List	110
APPENDICES	111
<hr/>	
Appendix 1 Module Label	111
Appendix 2 I/O Signals	113
List of I/O signals	113
Details of input signals	114
Details of output signals	121
Appendix 3 Buffer Memory	124
List of buffer memory addresses	124
Details of buffer memory addresses	136
Appendix 4 Dedicated Instruction	174
Instruction list	174
Appendix 5 Operation Examples of When the Remote Head Module Is Mounted	175
System configuration example	175
Setting in the master station	176
Setting in the intelligent device station	179
Checking the network status	182
Program examples	182
Appendix 6 Added or Changed Functions	185
INDEX	186
<hr/>	
REVISIONS	188
WARRANTY	189
TRADEMARK	190

RELEVANT MANUALS

Manual name [manual number]	Description	Available form
MELSEC iQ-R Digital-Analog Converter Module User's Manual (Application) [SH-081237ENG] (this manual)	Functions, parameter setting, troubleshooting, I/O signals, and buffer memory of the D/A converter module	Print book e-Manual PDF
MELSEC iQ-R Digital-Analog Converter Module User's Manual (Startup) [SH-081235ENG]	Specifications, procedures before operation, wiring, operation example, and offset/gain setting of the D/A converter module	Print book e-Manual PDF
MELSEC iQ-R Programming Manual (Module Dedicated Instructions) [SH-081976ENG]	Dedicated instructions for the intelligent function modules	e-Manual PDF



e-Manuals are electronic book-type manuals for Mitsubishi Electric FA products that can be read with a dedicated tool.

The following shows the features of e-Manuals.

- Desired information can be searched for from multiple manuals at a time. (Manual cross search)
- Other manuals can be referred to from links in a manual.
- Desired hardware specifications can be checked from each part in the illustrations of products.
- Information frequently referred to can be registered as a favorite.
- Sample programs can be copied to an engineering tool.

TERMS

Unless otherwise specified, this manual uses the following terms.

Term	Description
D/A converter module	The abbreviation for the MELSEC iQ-R series digital-analog converter module
GX Works3	The product name of the software package for the MELSEC programmable controllers
Watchdog timer error	An error that occurs if the internal processing of the D/A converter module is abnormal. Watchdog timer enables the module to monitor its own internal processing.
Engineering tool	A generic term for GX Works3
Factory default setting	A generic term for analog output ranges of 0 to 10V, 0 to 5V, 1 to 5V, -10 to 10V, 0 to 20mA, and 4 to 20mA
Normal mode	Setting values of the operation mode setting: normal mode and offset/gain setting mode
Offset/gain setting mode	
Synchronization normal output mode	When the inter-module synchronization function target is enabled, a value is set to CH□ Synchronization digital value using a synchronous interrupt program and the value is output on the set synchronization cycle.
Buffer memory	A memory in an intelligent function module, where data (such as setting values and monitoring values) exchanged with a CPU module are stored
User range	An analog output range where any value can be set. Set the user range in the offset/gain setting.
R mode	A mode that the module operates with the buffer memory map that memory areas have been newly laid out in the MELSEC iQ-R series.
Q compatible mode	A mode that the module operates with the buffer memory map converted to the equivalent map of the MELSEC-Q series.
Global label	A label that is valid for all program data created in the project. The global label has two types: a module specific label (module label) generated automatically by GX Works3, and an optional label for which any device can be specified.
Module label	A label that represents a memory (I/O signals and buffer memory areas) specific to each module in a given character string. Through the module used, GX Works3 automatically generates this label, which can be used as a global label.
Remote head module	The abbreviation for the RJ72GF15-T2 CC-Link IE Field Network remote head module

1 FUNCTIONS

This chapter describes the functions of the D/A converter module and the setting procedures for those functions. For details of the I/O signals and the buffer memory, refer to the following.

- ☞ Page 114 Details of input signals
- ☞ Page 121 Details of output signals
- ☞ Page 136 Details of buffer memory addresses

Point

- This chapter describes I/O signals and buffer memory addresses for CH1. For details on the I/O signals and buffer memory addresses for CH2 or later, refer to the following.
 - ☞ Page 113 List of I/O signals
 - ☞ Page 124 List of buffer memory addresses
 - □ in error codes and alarm codes indicates a channel where an error or alarm has occurred. A numerical value corresponding to the error comes in △. For details, refer to the following.
 - ☞ Page 106 Error Code List
 - ☞ Page 110 Alarm Code List
-

1.1 Modes

The D/A converter module has the normal mode and offset/gain setting mode. Change the mode according to the function used.

The following describes each mode.

Point

In each operation mode, the Q compatible mode function that is executed with the buffer memory layout of the D/A converter module converted to the equivalent of the Q series can also be selected.

Normal mode

The normal mode is classified into the normal output mode and wave output mode. In this manual, the normal mode means both of the normal output mode and waveform output mode.

Normal output mode

This output mode is for performing the normal D/A conversion. The value set in 'CH1 Digital value' (Un\G460) is output in analog after the D/A conversion.

Wave output mode

This output mode is for performing the wave output. The value set in 'Wave data registry area' (Un\G10000 to Un\G89999) is output in analog after the D/A conversion.

For details of the wave output function, refer to the following.

 Page 38 Wave Output Function

Offset/gain setting mode

This mode is for performing the offset/gain setting.

For details on the offset/gain setting, refer to the following.

 MELSEC iQ-R Digital-Analog Converter Module User's Manual (Startup)

Mode transitions

The following figure and table describe the transition condition for each mode.

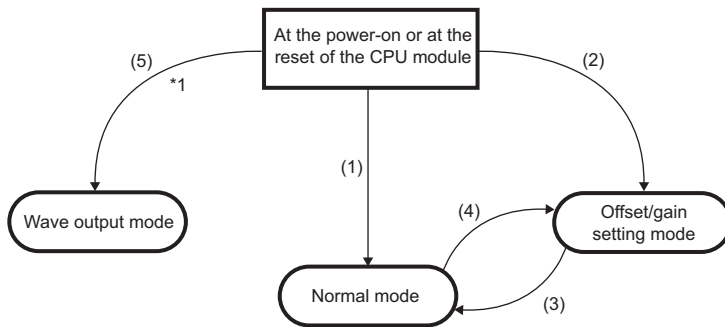

No.	Transition condition				
(1)	Set "Operation mode setting" to "Normal mode (D/A conversion process)" in "Basic settig" of the engineering tool and set "Output mode setting" to "Normal output mode".				
(2)	Set "Operation mode setting" to "Offset/gain setting mode" in "Basic settig" of the engineering tool.				
(3)	Perform the mode transition by either of the following methods. <table border="1"> <tr> <td>Method 1</td> <td>Execute the G(P).OFFGAN instruction (Argument "S": 0: Transition to the normal output mode).</td> </tr> <tr> <td>Method 2</td> <td>Set the following values for 'Mode switching setting' (Un\G296, Un\G297) and turn on and off 'Operating condition setting request' (Y9). <ul style="list-style-type: none"> • Un\G296: 5260H • Un\G297: 4441H </td> </tr> </table>	Method 1	Execute the G(P).OFFGAN instruction (Argument "S": 0: Transition to the normal output mode).	Method 2	Set the following values for 'Mode switching setting' (Un\G296, Un\G297) and turn on and off 'Operating condition setting request' (Y9). <ul style="list-style-type: none"> • Un\G296: 5260H • Un\G297: 4441H
Method 1	Execute the G(P).OFFGAN instruction (Argument "S": 0: Transition to the normal output mode).				
Method 2	Set the following values for 'Mode switching setting' (Un\G296, Un\G297) and turn on and off 'Operating condition setting request' (Y9). <ul style="list-style-type: none"> • Un\G296: 5260H • Un\G297: 4441H 				
(4)	Perform the mode transition by either of the following methods. <table border="1"> <tr> <td>Method 1</td> <td>Execute the G(P).OFFGAN instruction (Argument "S": 1: Transition to the offset/gain setting mode).</td> </tr> <tr> <td>Method 2</td> <td>Set the following values for 'Mode switching setting' (Un\G296, Un\G297) and turn on and off 'Operating condition setting request' (Y9). <ul style="list-style-type: none"> • Un\G296: 4441H • Un\G297: 5260H </td> </tr> </table>	Method 1	Execute the G(P).OFFGAN instruction (Argument "S": 1: Transition to the offset/gain setting mode).	Method 2	Set the following values for 'Mode switching setting' (Un\G296, Un\G297) and turn on and off 'Operating condition setting request' (Y9). <ul style="list-style-type: none"> • Un\G296: 4441H • Un\G297: 5260H
Method 1	Execute the G(P).OFFGAN instruction (Argument "S": 1: Transition to the offset/gain setting mode).				
Method 2	Set the following values for 'Mode switching setting' (Un\G296, Un\G297) and turn on and off 'Operating condition setting request' (Y9). <ul style="list-style-type: none"> • Un\G296: 4441H • Un\G297: 5260H 				
(5)	Set "Operation mode setting" to "Normal mode (D/A conversion process)" in "Basic settig" of the engineering tool and set "Output mode setting" to "Wave output mode".				

*1 The wave output mode is independent of the other modes. After the module is powered on in the wave output mode, the transition to the other modes is disabled.

After the module is powered on in any mode other than the wave output mode, the transition to the wave output mode is also disabled.

Checking method

The currently selected mode can be checked with the following items.

Mode	RUN LED status	Stored value of 'Output mode' (Un\G60)	'Offset/gain setting mode status flag' (XA)	
Normal mode	Normal output mode	ON	0	OFF*1
	Wave output mode	ON	1	OFF
Offset/gain setting mode	Flashing	0	ON*1	

*1 When 'User range write request' (YA) is off

1.2 Range Switching Function

The output range of the analog output can be switched for each channel. Switching the range makes it possible to change the I/O conversion characteristic.

Setting procedure

Set the output range to be used in "Output range setting".

Navigation window ⇒ [Parameter] ⇒ [Module Information] ⇒ Module name ⇒ [Module parameter] ⇒ "Basic settig" ⇒ "Range switching function"

Output range setting	Digital input range		
	R60DA4	R60DAV8	R60DAI8
4 to 20mA	0 to 32000	—	0 to 32000
0 to 20mA			
1 to 5V	0 to 32000	0 to 32000	—
0 to 5V			
-10 to 10V	-32000 to 32000	-32000 to 32000	—
User range (Voltage)	-32000 to 32000	-32000 to 32000	—
User range (Current)	-32000 to 32000	—	-32000 to 32000

After the data is written, the range is switched when the programmable power supply is turned off and on or when the CPU module is reset.

Point

The following buffer memory areas are used to monitor the range setting and to switch the range.

- 'CH1 Range setting' (Un\G598)
- 'CH1 Range setting monitor' (Un\G430)

For details on the buffer memory areas, refer to the following.

- ☞ Page 164 CH1 Range setting
- ☞ Page 145 CH1 Range setting monitor

Precautions

The output range cannot be changed for channels set to D/A conversion disabled. To change the output range, set "D/A conversion enable/disable setting" to "D/A conversion enabled" and 'CH1 Output enable/disable flag' (Y1) to OFF.

1.3 D/A Conversion Enable/Disable Function

Set whether to enable or disable the D/A conversion for each channel.

Disabling the D/A conversion for unused channels reduces the D/A conversion cycles.

Setting procedure

Set "D/A conversion enable/disable setting" to "D/A conversion enable" or "D/A conversion disable".

Navigation window ⇒ [Parameter] ⇒ [Module Information] ⇒ Module name ⇒ [Module parameter] ⇒ "Basic setting" ⇒ "D/A conversion enable/disable function"

1.4 D/A Output Enable/Disable Setting Function

Specify whether to output the D/A conversion value or offset value for each channel.

The conversion speed is a constant, regardless of the output enable/disable state.

Setting procedure

Set to enable or disable the D/A output for each channel with 'CH1 Output enable/disable flag' (Y1).

'CH1 Output enable/disable flag' (Y1)	Analog output
Enable (ON)	The D/A conversion value is output.
Disable (OFF)	The offset value is output.

1.5 Analog Output HOLD/CLEAR Function

Set whether to hold or clear the analog output value that has been output when the operating status of the CPU module is RUN, STOP, or stop error.

The HOLD/CLEAR setting can be checked with 'CH1 HOLD/CLEAR function setting monitor' (Un\G431).

Operation

When the operating status of the CPU module is RUN, STOP, or stop error, the analog output status changes as shown in the following table, depending on the combination of the settings of the analog output HOLD/CLEAR setting, 'CH1 D/A conversion enable/disable setting' (Un\G500), and 'CH1 Output enable/disable flag' (Y1).

■In the normal output mode

Execution status	CH1 D/A conversion enable/disable setting (Un\G500)	Enable			Disable
	CH1 Output enable/disable flag (Y1)	Enable		Disable	Enable or disable
	Analog output HOLD/CLEAR setting	HOLD	CLEAR	HOLD or CLEAR	HOLD or CLEAR
Analog output produced when the CPU module is in the RUN status		The digital value converted in analog is output.		Offset value	0V/0mA
Analog output produced when the CPU module is in the STOP state		Hold	Offset value	Offset value*2	0V/0mA
Analog output produced when the CPU module is in the stop error state		Hold	Offset value	Offset value	0V/0mA
Analog output produced when a watchdog timer error*1 occurs		0V/0mA	0V/0mA	0V/0mA	0V/0mA

*1 The error occurs due to a hardware failure of the D/A converter module or other causes. 'Module READY' (X0) and the RUN LED of the D/A converter module turn off.

When a watchdog timer error occurs, 'Module READY' (X0) and the RUN LED of the D/A converter module turn off.

*2 The following operation is performed when the CPU module is in the STOP state, the D/A conversion enable/disable setting is set to D/A conversion enable (0) for the channel where HOLD is set, and 'Operating condition setting request' (Y9) is turned on and off.

When Output enable/disable flag is off: Outputs 0V/0mA.

When Output enable/disable flag is turned on: Outputs the offset value.

■In the wave output mode

Execution status	CH1 D/A conversion enable/disable setting (Un\G500)	Enable						Disable	
	CH1 Output enable/disable flag (Y1)	Enable			Disable	Enable or disable			
	Analog output HOLD/CLEAR setting	HOLD			CLEAR			HOLD or CLEAR	
	Wave output status	Output	Stop	Pause	Output	Stop	Pause	HOLD or CLEAR	
Analog output produced when the CPU module is in the RUN status		Wave data	*2	Hold	Wave data	*2	Offset value	Offset value	0V/0mA
Analog output produced when the CPU module is in the STOP state		Hold			Offset value			Offset value	0V/0mA
Analog output produced when the CPU module is in the stop error state		Hold			Offset value			Offset value	0V/0mA
Analog output produced when a watchdog timer error*1 occurs		0V/0mA			0V/0mA			0V/0mA	0V/0mA

*1 The error occurs due to a hardware failure of the D/A converter module or other causes. 'Module READY' (X0) and the RUN LED of the D/A converter module turn off.

When a watchdog timer error occurs, 'Module READY' (X0) and the RUN LED of the D/A converter module turn off.

*2 The output set in 'CH1 Output setting during wave output stop' (Un\G524).

■ In the synchronization normal output mode

Execution status	CH1 D/A conversion enable/disable setting (Un\G500)	Enable			Disable
	CH1 Output enable/disable flag (Y1)	Enable		Disable	Enable or disable
	Analog output HOLD/CLEAR setting	HOLD	CLEAR	HOLD or CLEAR	HOLD or CLEAR
External power supply READY flag (X7): On	Analog output produced when the CPU module is in the RUN status	CH1 Synchronization digital value (Un\G9500)		Offset value	0V/0mA
	Analog output produced when the CPU module is in the STOP state	Hold	Offset value	Offset value ^{*2}	0V/0mA
	Analog output produced when the CPU module is in the stop error state	Hold	Offset value	Offset value	0V/0mA
External power supply READY flag (X7): Off		0V/0mA	0V/0mA	0V/0mA	0V/0mA
Analog output produced when a watchdog timer error ^{*1} occurs		0V/0mA	0V/0mA	0V/0mA	0V/0mA

*1 The error occurs due to a hardware failure of the D/A converter module or other causes. 'Module READY' (X0) and the RUN LED of the D/A converter module turn off.

When a watchdog timer error occurs, 'Module READY' (X0) and the RUN LED of the D/A converter module turn off.

Setting procedure

Set "Analog output HOLD/CLEAR setting" to "HOLD" or "CLEAR".

 Navigation window ⇒ [Parameter] ⇒ [Module Information] ⇒ Module name ⇒ [Module parameter] ⇒ "Basic setting" ⇒ "Output mode setting function"

Precautions for when the remote head module has been mounted

When the D/A converter module has been mounted on the remote head module, set whether to hold or clear the analog output value that has been output when the host station is disconnected with "CPU error output mode setting" of the module parameter.

The following describes the settings required for using "CPU error output mode setting".

- Enable the station-based block data assurance for cyclic data on the sending side.
- To hold the analog output value, set "CPU error output mode setting" to "Hold". The analog output HOLD/CLEAR function setting is disabled.

This setting is enabled for each module and cannot be set for each channel. To match the output status of when a stop error occurs or the CPU module is in the STOP state and that of when the host station is disconnected, set "Analog output HOLD/CLEAR setting" to the same value in all the channels.

Operating status	CPU error output mode setting ^{*1}	Analog output HOLD/CLEAR setting (Set the same value in all the channels.)
The analog output value is held.	Hold	HOLD
The analog output value is cleared. (The offset value is output.)	Clear	CLEAR

*1 "CPU error output mode setting" is enabled in the following cases.

- When the host station is disconnected due to a network error
- When the data link is stopped by the CC-Link IE Field Diagnostics of the engineering tool

1.6 Analog Output Test when CPU Module is in STOP Status Function

Analog output tests can be carried out when the CPU module is in the STOP status.

The following functions are enabled during the analog output test.

- Scaling function (Page 23 Scaling Function)
- Shift function (Page 26 Shift Function)
- Alert output function (Page 28 Alert Output Function)

When a digital value that is out of the setting range is written, a digital value setting range error (error code: 191□H) occurs and the corresponding check code is stored in 'CH1 Setting value check code' (Un\G400).

Operation

By forcibly turning on 'CH1 Output enable/disable flag' (Y1) when the CPU module is in the STOP state, the analog output value is changed from the offset value to the D/A-converted analog output value.

The following figure shows the relation between 'CH1 Output enable/disable flag' (Y1) and the analog output value of the CPU module in the STOP state when the analog output HOLD/CLEAR setting is set to CLEAR (0).

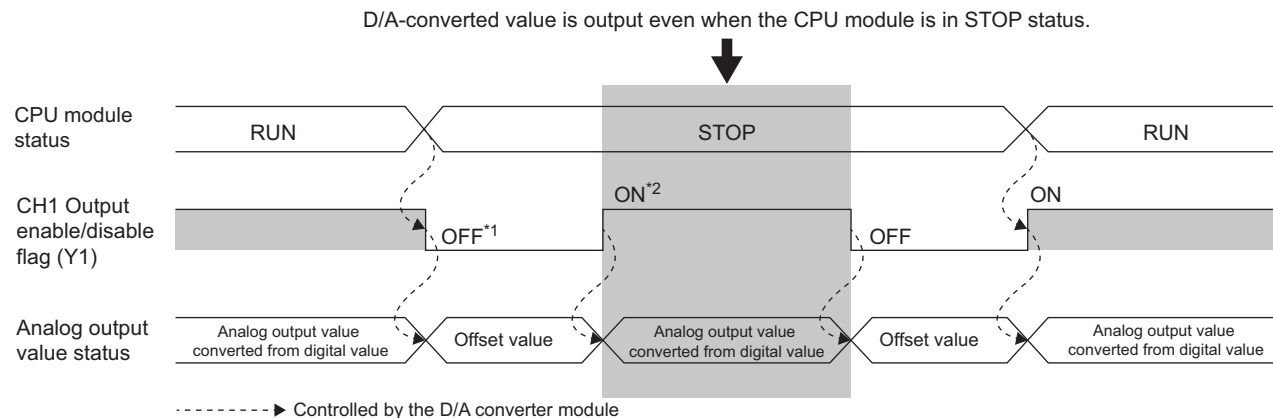

*1 'CH1 Output enable/disable flag' (Y1) turns off when the status of the CPU module is changed into STOP.

*2 By forcibly turning on 'CH1 Output enable/disable flag' (Y1), the analog output value is changed from the offset value to the D/A-converted analog output value.

Setting procedure

To perform an analog output test, configure the settings in the device test of the engineering tool following the procedure shown below.

1. Set 'CH1 D/A conversion enable/disable setting' (Un\G500) of the buffer memory to D/A conversion enabled (0).
2. Turn on 'Operating condition setting request' (Y9).
3. Check that 'Operating condition setting completed flag' (X9) turns off, and turn off 'Operating condition setting request' (Y9).
4. Set the digital value equivalent to the analog value to be output for 'CH1 Digital value' (Un\G460) in the buffer memory.
5. Turn on 'CH1 Output enable/disable flag' (Y1).

1.7 Scaling Function

This function performs the scale conversion on digital values within a specified range between a scaling upper limit value and a scaling lower limit value. The program for scale conversion can be omitted.

Operation

The scale conversion is performed for the set 'CH1 Digital value' (Un\G460) using 'CH1 Scaling upper limit value' (Un\G504) and 'CH1 Scaling lower limit value' (Un\G506), and the value after the scale conversion is used for the D/A conversion. (In the scale conversion, values after the decimal point are rounded off.)

When the relation between the set upper limit value and lower limit value is Scaling lower limit value > Scaling upper limit value, the scale conversion can be performed according to a negative slope.

Concept of scaling setting

The necessary settings for the scaling lower limit value and scaling upper limit value depend on whether the factory default setting or the user range setting is used for the analog output range.

■When the factory default setting is used for the analog output range

- For the scaling upper limit value, set a value corresponding to the upper limit value of the set analog output value.
- For the scaling lower limit value, set a value corresponding to the lower limit value of the set analog output value.

■When the user range setting is used for the analog output range

- Set a value corresponding to the gain value for the scaling upper limit value.
- Set a value corresponding to the offset value for the scaling lower limit value.

Calculating the scaling value

For D/A conversion, the scaling value is calculated based on the following equations.

■When the factory default setting is used for the output range

- When the voltage is 1 to 5V or 0 to 5V and the current is 4 to 20mA or 0 to 20mA

$$\text{Digital value used for D/A conversion} = \frac{32000}{S_H - S_L} \times (D_X - S_L)$$

- When the voltage is -10 to 10V

$$\text{Digital value used for D/A conversion} = \frac{64000}{S_H - S_L} \times (D_X - S_L) - 32000$$

■When the user range setting is used for the output range

$$\text{Digital value used for D/A conversion} = \frac{32000}{S_H - S_L} \times (D_X - S_L)$$

Item	Description
D _X	Digital value
S _H	Scaling upper limit value
S _L	Scaling lower limit value

Setting procedure

1. Set "D/A conversion enable/disable setting" to "D/A conversion enable".
 Navigation window ⇒ [Parameter] ⇒ [Module Information] ⇒ Module name ⇒ [Module parameter] ⇒ "Basic settig" ⇒ "D/A conversion enable/disable function"
2. Set "Scaling enable/disable setting" to "Enable".
 Navigation window ⇒ [Parameter] ⇒ [Module Information] ⇒ Module name ⇒ [Module parameter] ⇒ "Application setting" ⇒ "Scaling setting"
3. Set values for "Scaling upper limit value" and "Scaling lower limit value".
 Set the values to satisfy the following relation.
 Scaling upper limit value ≠ Scaling lower limit value

Item	Setting range
Scaling upper limit value	-32000 to 32000
Scaling lower limit value	

Example of scaling setting

Ex.

When 14000 is set to the scaling upper limit value and 4000 is set to the scaling lower limit value for the channel with the output range of 0 to 5V

Analog output voltage (V)

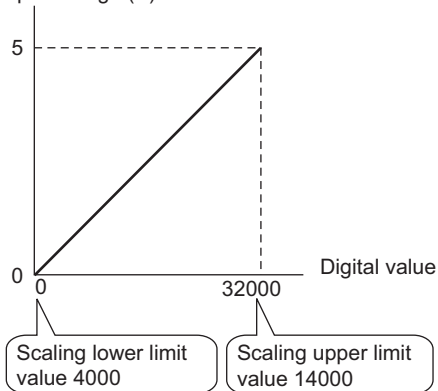

Digital value	Digital value after scaling	Output voltage (V)
4000	0	0
6000	6400	1
8000	12800	2
10000	19200	3
12000	25600	4
14000	32000	5

Precautions

- When the scaling function is used, the digital value can be set to a value out of the range between the scaling upper limit value and scaling lower limit value (in the dotted lines in the I/O characteristics graph) before being scaled. However, use the scaling function within the range of the analog output practical range (in the solid line in the I/O characteristics graph). If the value exceeds the analog output practical range, the maximum resolution and accuracy may not fall within the range of the performance specifications.
- The default digital value "0" may not be appropriate, depending on the scaling function setting.
In particular in the examples of when the output range is 0 to 5V, an out-of-range digital value error occurs if 'CH1 Output enable/disable flag' (Y1) is turned on with the digital value "0".
A digital value setting range error (error code: 191□H) occurs and 'Error flag' (XF) turns on, and the ERR LED lights.
Therefore, set an appropriate digital value within the scaling range before turning on 'CH1 Output enable/disable flag' (Y1).
- When using the user range, note that the scaling lower limit value is equal to the offset value.
- When the scaling function is enabled and the digital value after the scaling conversion is out of the digital setting range, a digital value setting range error (error code: 191□H) occurs and the corresponding check code is stored in 'CH1 Setting value check code' (Un\G400).
- The scaling function is enabled only for the normal output. When the scaling function is enabled while the wave output function is used, a scaling setting error in wave output mode (error code: 0B1□H) occurs and 'Alert output signal' (XE) turns on.

1.8 Shift Function

This function adds the set input value shift amount to the digital input value.

The analog output value reflects the change in the input value shift amount on a realtime basis. Therefore, fine adjustment can be easily performed when the system starts.

Operation

When the D/A conversion is performed on the digital value, the value obtained by adding 'CH1 Input value shift amount' (Un\G480) to 'CH1 Digital value' (Un\G460) is used for the D/A conversion.

When the digital value after the addition exceeds the range of -32768 to 32767 as the result of the shift processing, the value is fixed with the lower limit value (-32768) or the upper limit value (32767).

When a value is written to 'CH1 Input value shift amount' (Un\G480), the set value is added to the digital input value regardless of the ON/OFF state of 'Operating condition setting request' (Y9).

Setting procedure

Set the shift amount to "Input value shift amount".

Navigation window ⇒ [Parameter] ⇒ [Module Information] ⇒ Module name ⇒ [Module parameter] ⇒ "Application setting" ⇒ "Shift function"

Item	Setting range
Input value shift amount	-32768 to 32767

Setting example

Ex.

When the output range is 0 to 5V and the input value shift amount is +50

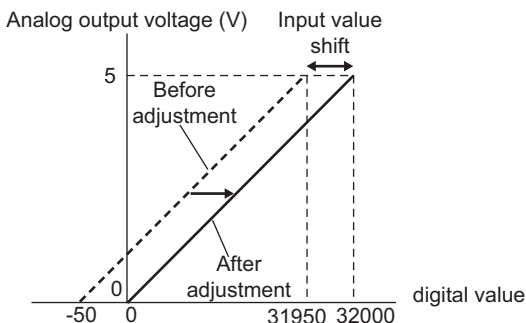

Digital value		Analog output voltage (V)
Before adjustment	After adjustment	
-50	0	0
31950	32000	5

Precautions

- Based on the digital value on which the shift-and-add is performed, the alert output function, scaling function, and rate control function are executed.
- When the value obtained by adding 'CH1 Input value shift amount' (Un\G480) to 'CH1 Digital value' (Un\G460) is out of the digital setting range, a digital value setting range error (error code: 191□H) occurs and the corresponding check code is stored in 'CH1 Setting value check code' (Un\G400).
- The shift function is enabled only for the normal output. When a value other than 0 is set in 'CH1 Input value shift amount' (Un\G480) while the wave output function is used, an input value shift amount setting error in wave output mode (alarm code: 0B2□H) occurs and 'Alert output signal' (XE) turns on. Although the wave output continues, 'CH1 Input value shift amount' (Un\G480) is not added to the wave data to be output.
- Even though 0 is set for 'CH1 Input value shift amount' (Un\G480) after an input value shift amount setting error in wave output mode has occurred, 'Alert output signal' (XE) does not turn off. Turn on and off 'Alert output clear request' (YE) to turn off 'Alert output signal' (XE). By this operation, 'Alert output signal' (X8) and the ALM LED turn off, and Latest alarm code is cleared.

1.9 Alert Output Function

This function outputs an alert when the digital value is larger than the alert output upper limit value or is smaller than the alert output lower limit value.

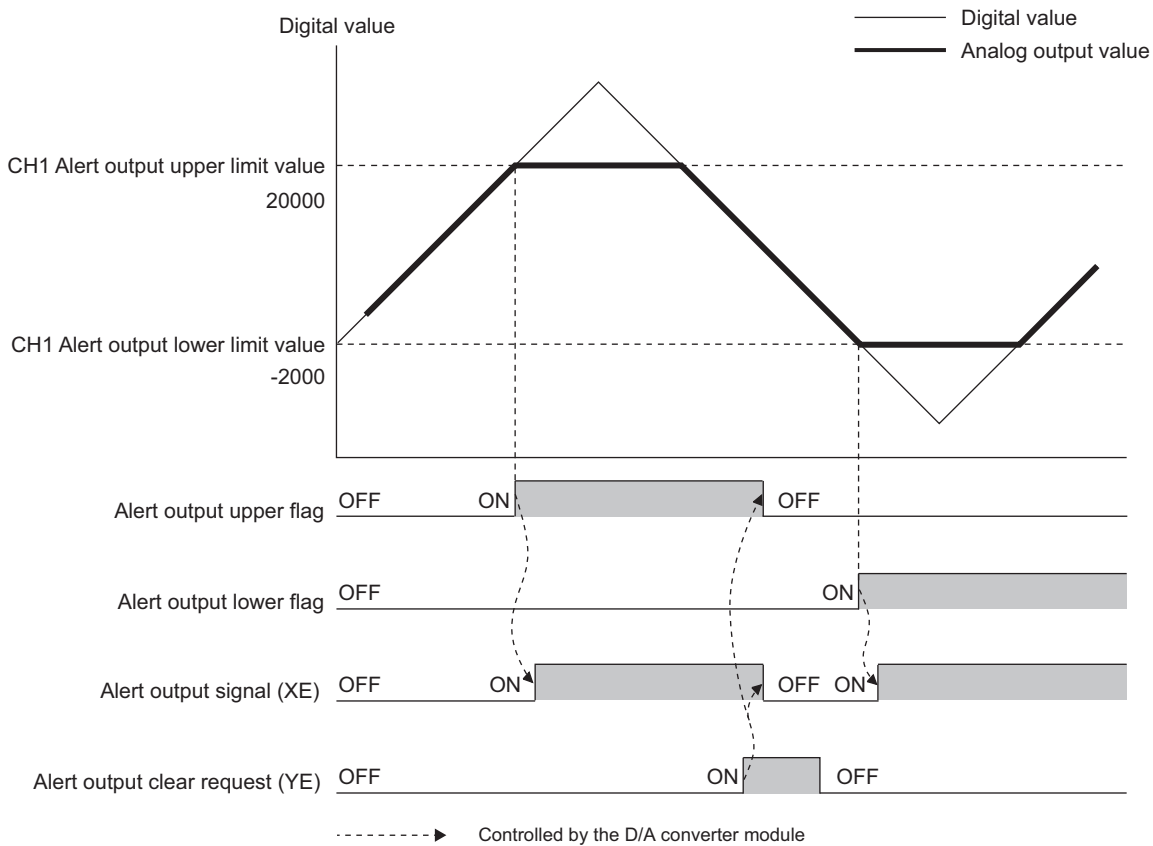

Operation

■Alert output notification

When 'CH1 Digital value' (Un\G460) is larger than 'CH1 Alert output upper limit value' (Un\G510) or is smaller than 'CH1 Alert output lower limit value' (Un\G512), either of 'Alert output upper limit flag' (Un\G36) or 'Alert output lower limit flag' (Un\G37), 'Alert output signal' (XE), and the ALM LED turn on to output an alert. In addition, an alarm code (080□H or 081□H) is stored in 'Latest alarm code' (Un\G2) when an alert has occurred.

When an alert has occurred, the set value of the alert output upper limit value or the alert output lower limit value is used as the digital value for the D/A conversion.

When 'CH1 Digital value' (Un\G460) is changed to a value smaller than 'CH1 Alert output upper limit value' (Un\G510) and larger than 'CH1 Alert output lower limit value' (Un\G512) after an alert has occurred, the analog output value returns to a normal value. However, 'Alert output upper limit flag' (Un\G36), 'Alert output lower limit flag' (Un\G37), and 'Alert output signal' (XE) are not cleared.

Clearing a warning

The alert output can be cleared in the following two methods:

After 'CH1 Digital value' (Un\G460) is set to be smaller than 'CH1 Alert output upper limit value' (Un\G510) and larger than 'CH1 Alert output lower limit value' (Un\G512)

- Turning on and off 'Alert output clear request' (YE)
- Turning on and off 'Operating condition setting request' (Y9)

The D/A converter module arranges the following status when an alert output is cleared.

- Clearing 'Alert output upper limit flag' (Un\G36) and 'Alert output lower limit flag' (Un\G37)
- Turning off 'Alert output signal' (XE)
- Turning off the ALM LED
- Clearing the alarm code stored in 'Latest alarm code' (Un\G2)

Setting procedure

1. Set "Alert output setting" to "Enable".

 Navigation window ⇒ [Parameter] ⇒ [Module Information] ⇒ Module name ⇒ [Module parameter] ⇒ "Application setting" ⇒ "Alert output function"

2. Set values for "Alert output upper limit value" and "Alert output lower limit value".

Set the values to satisfy the following relation.

Alert output upper limit value > Alert output lower limit value

Item	Setting range
Alert output upper limit value	-32768 to 32767
Alert output lower limit value	

Precautions

- When the shift function is used in the normal mode, 'CH1 Digital value' (Un\G460) on which the shift-and-add is performed is the alert detection target. Set the alert output upper/lower limit values in consideration of the shift-and-add.

1.10 Rate Control Function

The increment/decrement of the analog output value per 80μs is restricted to prevent the sudden change of the analog output value.

When the inter-module synchronization function is enabled, the rate control function cannot be used.

Operation

When the change amount of 'CH1 Digital value' (Un\G460) is larger than the value set in 'CH1 Increase digital limit value' (Un\G514) or 'CH1 Decrease digital limit value' (Un\G516), this function changes 'CH1 Digital value' (Un\G460) by the limit values set for each digital limit value.

The increment/decrement values per 80μs are set for 'CH1 Increase digital limit value' (Un\G514) and 'CH1 Decrease digital limit value' (Un\G516). However, the actual update cycle of the output value of the corresponding channel is (80μs × Number of conversion-enabled channels).

Therefore, the analog output value increases or decreases per update cycle as follows:

First time: The D/A conversion value of the increase/decrease digital limit value

Second time or later: The D/A conversion value of (Increase/decrease digital limit value × Number of conversion-enabled channels)

Setting procedure

1. Set "Rate control enable/disable setting" to "Enable".

Navigation window ⇒ [Parameter] ⇒ [Module Information] ⇒ Module name ⇒ [Module parameter] ⇒ "Application setting" ⇒ "Rate control function"

2. Set values for "Increase digital limit value" and "Decrease digital limit value".

Item	Setting range
Increase digital limit value	0 to 64000
Decrease digital limit value	

Precautions

- The setting of the shift function is enabled during the rate control.
- When the alert output function is enabled, the alert determination is performed to the set 'CH1 Digital value' (Un\G460). Note that an alert does not occur at the timing when the digital value changed by the rate control function exceeds the upper/lower limit value.
- The rate control does not function during the analog output test for when the CPU module is in the STOP state.
- With Analog output HOLD/CLEAR setting set to a value other than HOLD, the analog output value changes when the CPU module is in the STOP state but the rate control function does not function.
- When the CPU module status changes while the D/A conversion and D/A output are enabled and the analog output HOLD/CLEAR setting is set to CLEAR, the rate control function operates as follows:
When the CPU module status changes from RUN to STOP (error), the rate control does not function. When the CPU module status changes from STOP (error) to RUN, the rate control functions.

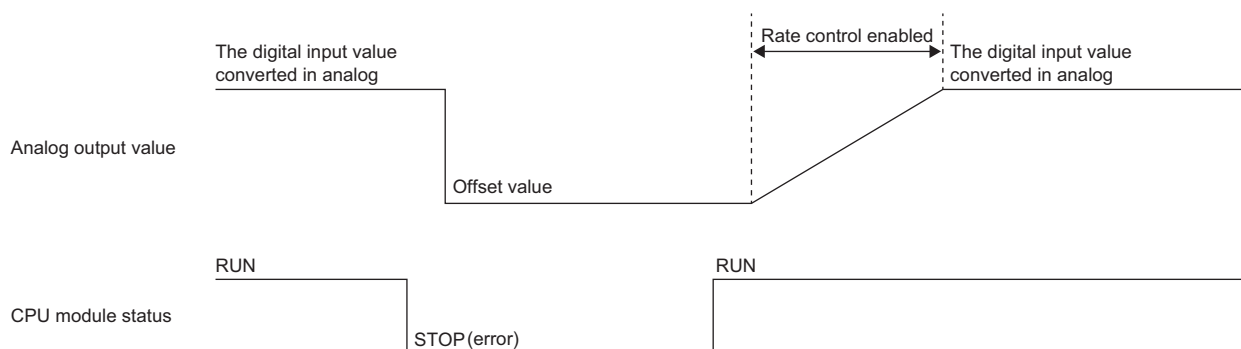

- When the CPU module status is changed from STOP (error) to RUN while the D/A conversion is enabled, the D/A output is set to HOLD, and the rate control is enabled, the analog output is restarted from the offset value.

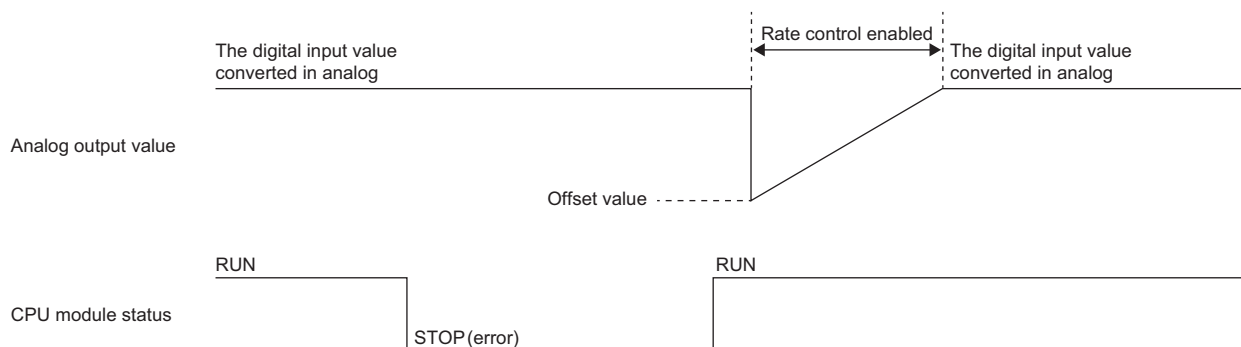

- When the D/A conversion is enabled and the D/A output is disabled, the rate control does not function.
- When a value out of the setting range is written to 'CH1 Digital value' (Un\G460) during the rate control, the rate control is performed with the upper or lower limit value of the setting range. In addition, the check result is stored in 'CH1 Setting value check code' (Un\G400).
- When the external power supply is turned off during the rate control, the rate control does not function and the analog output value changes to 0V/0mA. When the external power supply is recovered, the rate control is restarted from the offset value.
- The rate control function is enabled only for the normal output. When the rate control function is enabled while the wave output function is used, a rate control setting error in wave output mode (alarm code: 0B3□H) occurs and 'Alert output signal' (XE) turns on.

1.11 External Power Supply Disconnection Detection Function

This function detects that the external power supply 24VDC is not supplied or the supply stops.

When the external power supply disconnection is detected, 'External power supply READY flag' (X7) turns off, and the analog output value becomes 0V/0mA regardless of the other settings.

Operation

When the external power supply is not input or when 200ms has not yet elapsed after the power supply is input, the power supply is regarded as disconnected and 'External power supply READY flag' (X7) turns off.

When the external power supply input stops, the external power supply is regarded as disconnected and 'External power supply READY flag' (X7) turns off.

Precautions

When the external power supply does not satisfy the requirements of the performance specifications, the external power supply is regarded as disconnected.

For the performance specifications of the external power supply, refer to the following.

 MELSEC iQ-R Digital-Analog Converter Module User's Manual (Startup)

1.12 Disconnection Detection Function

The R60DA4 and R60DAI8 can detect a disconnection by monitoring the analog output value. This function is enabled only when the analog output range is 4 to 20mA. A disconnection can be detected for each channel.

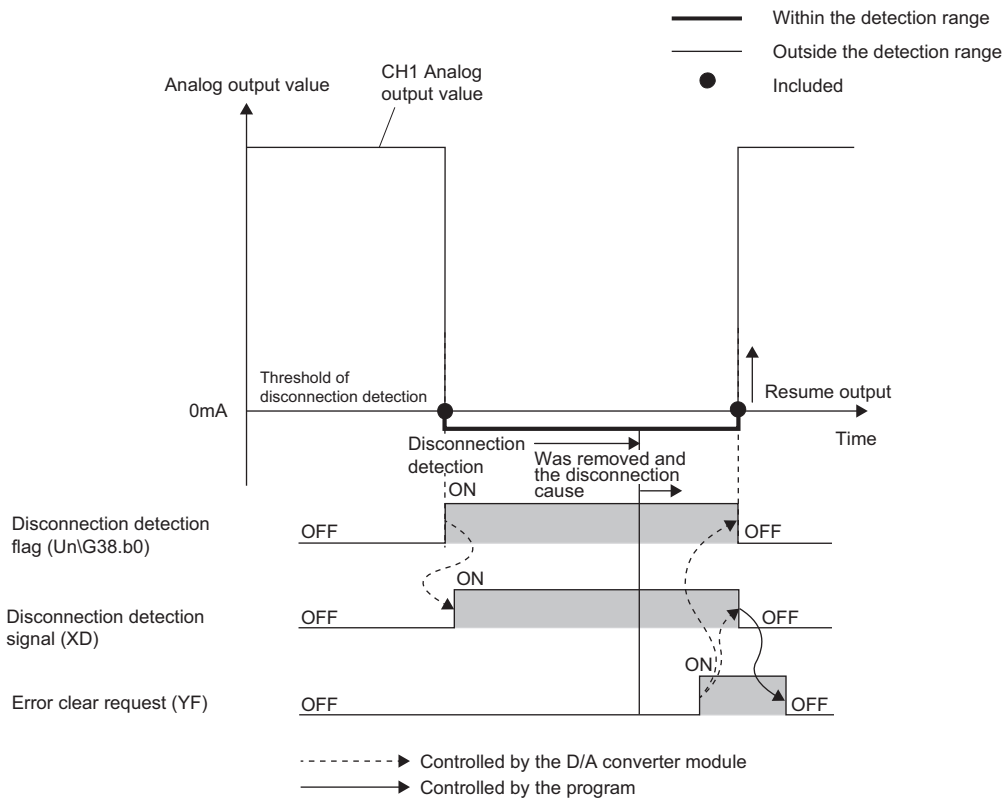

Operation

■ Disconnection detection

A disconnection can be detected when the analog output range is 4 to 20mA and 'CH1 D/A conversion enable/disable setting' (UnG500) is set to D/A conversion enabled (0).

■ Operations performed when a disconnection is detected

When a disconnection is detected, the disconnection is notified by turning on 'Disconnection detection flag' (UnG38), 'Disconnection detection signal' (XD), and the ERR LED.

In addition, an error code (1C4□H) is stored in 'Latest error code' (UnG0).

Even if the disconnection cause is eliminated, the analog output does not restart automatically to prevent an incorrect output.

To restart the analog output, check 'CH1 Digital value' (UnG460) and turn on and off 'Error clear request' (YF). According to the status of 'CH1 Output enable/disable flag' (Y1), the analog output restarts.

When the analog output restarts, 'Disconnection detection flag' (UnG38) of the corresponding channel is cleared. When the analog output of all the channels restarts, 'Disconnection detection signal' (XD) is cleared.

1.13 Interrupt Function

The D/A converter module executes the interrupt program of the CPU module when an interrupt factor such as a disconnection or alert output is detected.

For the D/A converter module, the maximum number of interrupt pointers available is 16 per module.

Operation

■Detecting an interrupt factor

When an interrupt factor occurs, an interrupt request is sent to the CPU module at the same time as 'Interrupt factor detection flag [n]' (Un\G4 to Un\G19) is turned to Interrupt factor (1).

■How to reset an interrupt factor

When Reset request (1) is set to 'Interrupt factor reset request [n]' (Un\G156 to Un\G171) corresponding to the interrupt factor, the specified interrupt factor is reset and 'Interrupt factor detection flag [n]' (Un\G4 to Un\G19) changes to No interrupt factor (0).

Setting procedure

To use the interrupt function, set "Condition target setting", "Condition target channel setting", "Interrupt factor transaction setting", and "Interrupt pointer" in the engineering tool. After completing the settings, write the project to enable the settings.

 Navigation window ⇒ [Parameter] ⇒ [Module Information] ⇒ Module name ⇒ [Module parameter] ⇒ "Interrupt setting"
The following table shows the setting items on the interrupt setting window.

Item	Description
Condition target setting	Select a factor of the target for the interrupt detection.
Condition target channel setting	Select a target channel when the condition target setting for the interrupt detection is channel specification.
Interrupt factor transaction setting	Set an interrupt request for when the same interrupt factor occurs during the interrupt factor detection.
Interrupt pointer	Specify the number of an interrupt pointer that is initiated at the detection of an interrupt factor.

■Condition target setting

Select a factor of the condition target setting for the interrupt detection.

For details on the factors to be detected, refer to the following.

 Page 142 Condition target setting [n]

■Condition target channel setting

Select a target channel when the condition target setting for the interrupt detection is channel specification.

Item	Setting value*1								
Condition target channel setting	0: All channels	1: CH1	2: CH2	3: CH3	4: CH4	5: CH5	6: CH6	7: CH7	8: CH8

*1 When X signal is specified for the condition target setting, this value is ignored.

■Interrupt factor generation setting

Set an interrupt request for when the same interrupt factor occurs during the interrupt factor detection.

- When Interrupt resend request (0) is set and the same interrupt factor occurs during the interrupt factor detection, an interrupt request is sent to the CPU module again.
- When No interrupt resend request (1) is set and the same interrupt factor occurs during the interrupt factor detection, an interrupt request is not sent to the CPU module.

■Interrupt pointer

To the interrupt pointer, specify a number of an interrupt pointer to be activated when an interrupt factor is detected or the label related to the interrupt pointer. For details on the interrupt pointers, refer to the following.

 MELSEC iQ-R CPU Module User's Manual (Application)

-
- If 'Condition target setting [n]' (Un\G232 to Un\G247) is Disable (0), an interrupt request is not sent to the CPU module.
 - To reset the interrupt factor, set Reset request (1) until 'Interrupt factor detection flag [n]' (Un\G4 to Un\G19) changes to No interrupt factor (0).
 - Resetting interrupt factors is executed only when 'Interrupt factor reset request [n]' (Un\G156 to Un\G171) changes from No reset request (0) to Reset request (1).
 - Multiple interrupt pointers can also share the same setting of 'Condition target setting [n]' (Un\G232 to Un\G247). When interrupts with the same settings occur in 'Condition target setting [n]' (Un\G232 to Un\G247), the interrupt program is executed in order of the priority of the interrupt pointers. For the priority of the interrupt pointers, refer to the following.

 MELSEC iQ-R CPU Module User's Manual (Application)

- When All channels (0) is set for 'Condition target channel setting [n]' (Un\G264 to Un\G279) and an interrupt detection target for each channel is set to 'Condition target setting [n]' (Un\G232 to Un\G247) such as Alert output flag (2), the interrupt requests that have the same interrupt factor are sent to the CPU module if alerts are issued in multiple channels. In this case, the CPU module executes multiple interrupt programs at a time and judges that the program cannot be normally finished due to the scan monitoring function of the CPU module, and a CPU module error may occur. When a CPU error occurs, refer to the following.

 MELSEC iQ-R CPU Module User's Manual (Application)

Setting example

Ex.

When the interrupt program (I50) is executed at the disconnection detection in any channel

- Parameter setting

Set "Interrupt setting" of [Module parameter] as follows.

No.	Condition target setting	Condition target channel setting	Interrupt pointer
1	Disconnection detection flag	All CH specification	I50

- Label setting



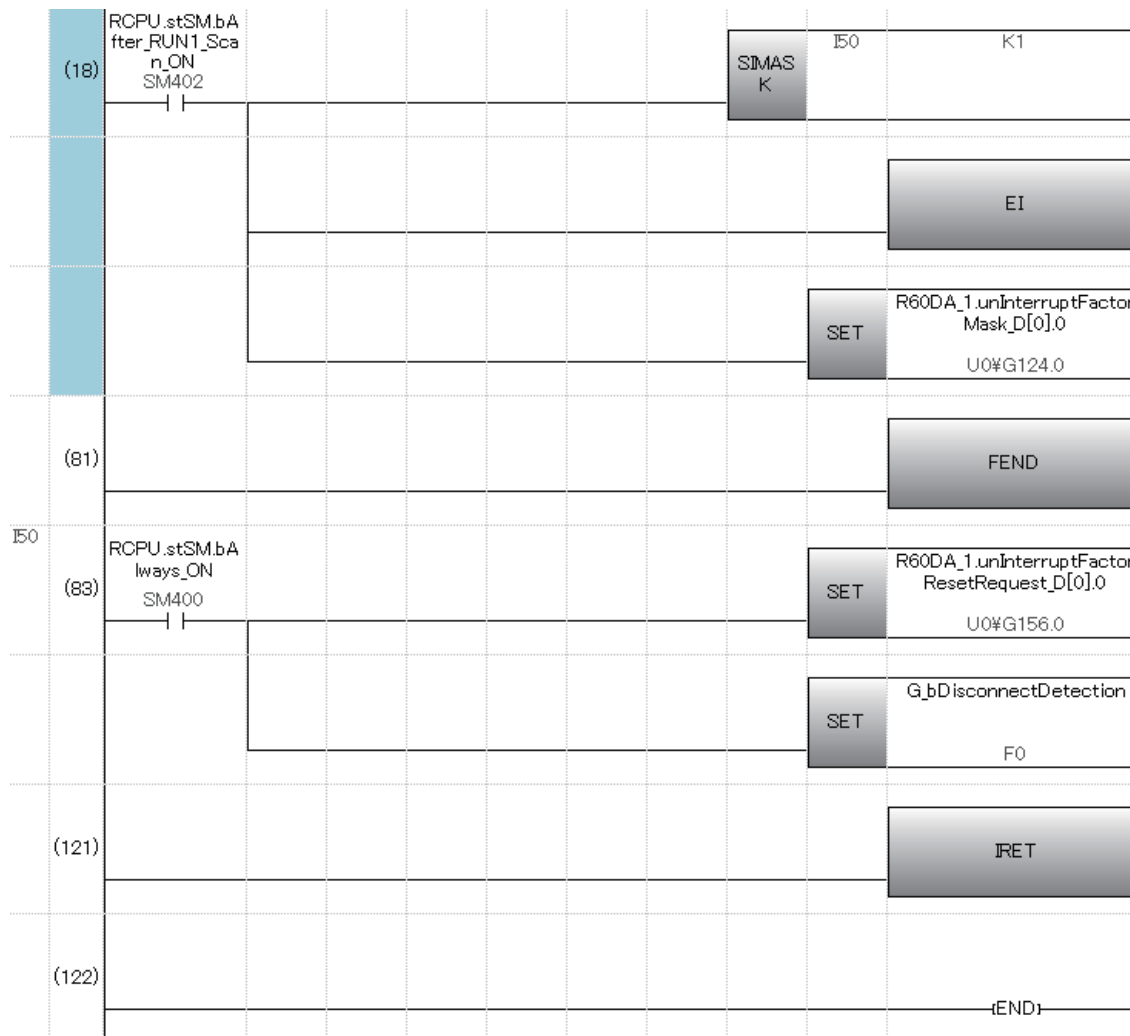



Classification	Label name	Description	Device	
Module label	RCPU.stSM.bAlways_ON	Always ON	SM400	
	RCPU.stSM.bAfter_RUN1_Scan_ON	ON for one scan after RUN	SM402	
	R60DA_1.unInterruptFactorMask_D[0].0	Interrupt factor mask [1]	U0\G124.0	
	R60DA_1.unInterruptFactorResetRequest_D[0].0	Interrupt factor reset request [1]	U0\G156.0	
Labels to be defined	Define global labels as shown below:			
	Label Name	Data Type	Class	Assign (Device/Label)
	1 G.bDisconnectDetection	Bit	VAR_GLOBAL	F0



- (18) Enable only the interrupt pointer I50.
Enable the interruption.
Clear Interrupt factor mask [1].
- (83) Turn on Interrupt factor reset request [1].
Perform the processing of when a disconnection is detected.

Wave output function procedure

The following shows how to use the wave output function.

- 1.** Creating wave data
 Page 46 Creating wave data
- 2.** Setting parameters of the wave output function
 Page 49 Setting parameters of the wave output function
- 3.** Writing wave output data to a file register (ZR) or CSV file
 Page 50 Writing data to a file register (ZR) or CSV file
- 4.** Parameter setting of the D/A converter module
 Page 51 Parameter setting of the D/A converter module
- 5.** Registering wave output data
 Page 52 Registering wave output data
- 6.** Starting/stopping/pausing wave output
 Page 54 Starting/stopping/pausing wave output

Wave output data can be easily created by using "Create Wave Output Data" of the engineering tool. These contents are written to the file registers (ZR) of the CPU module or CSV files.

Parameter settings for the wave output function

To use the wave output function, the parameters of the wave output function are required to be set on the "Create Wave Output Data" window.

Setting item	Reference
Output setting during wave output stop	Page 49 Setting parameters of the wave output function
Output value during wave output stop	
Wave pattern start address setting	
Wave pattern data points setting	
Wave pattern output repetition setting	
Constant for wave output conversion cycle	
Wave data registry area	

For details on each buffer memory area, refer to the following.

-  Page 136 Details of buffer memory addresses

Restrictions and precautions on the wave output function

The wave output function has the following restrictions and precautions.

■Output range setting

The user range cannot be used. When executing the wave output function, use the range other than the user range.

For the setting procedure of the output range, refer to the following.

☞ Page 18 Range Switching Function

■Scaling function

The scaling function cannot be used when the wave output function is selected. When executing the wave output function, disable the scaling function.

■Analog output HOLD/CLEAR function

The operation of the analog output HOLD/CLEAR function for the normal output differs from the operation for the wave output.

For details, refer to the following.

☞ Page 20 In the wave output mode

■Remote head module

When the D/A converter module is mounted together with the remote head module, function blocks (FBs) cannot be used. To execute the wave output function, refer to the following.

☞ Page 58 Registering data when the remote head module is used

Wave data

The wave data indicate the time-series arrangement of the digital input values to be output in analog. Up to 80000 points can be used. The wave data is registered in 'Wave data registry area' (Un\G10000 to Un\G89999).

Wave pattern

To use the wave output function, select any points from the registered wave data for each channel and set the wave pattern. The following table lists the setting contents for the wave pattern.

Setting item	Description
Wave pattern start address setting	Set the start address of the wave pattern to be output for each channel. The D/A conversion starts from the digital input value of the buffer memory address set in this area and the converted values are output sequentially.
Wave pattern data points setting	This area is for setting the points of the wave pattern to be output for each channel. From the start address of the wave pattern, the D/A conversion starts for the points of wave data set in this area and the converted values are output.

If the address value (total of the set values for "Wave pattern start address setting" and "Wave pattern data points setting" - 1) exceeds the last buffer memory address (Un\G89999) of the wave data registry area, an error occurs. The error code (1D9□H) is stored in 'Latest error code' (Un\G0), 'Error flag' (XF) turns on, and the ERR LED turns on.

Ex.

Setting example to output different waves from CH1 and CH2

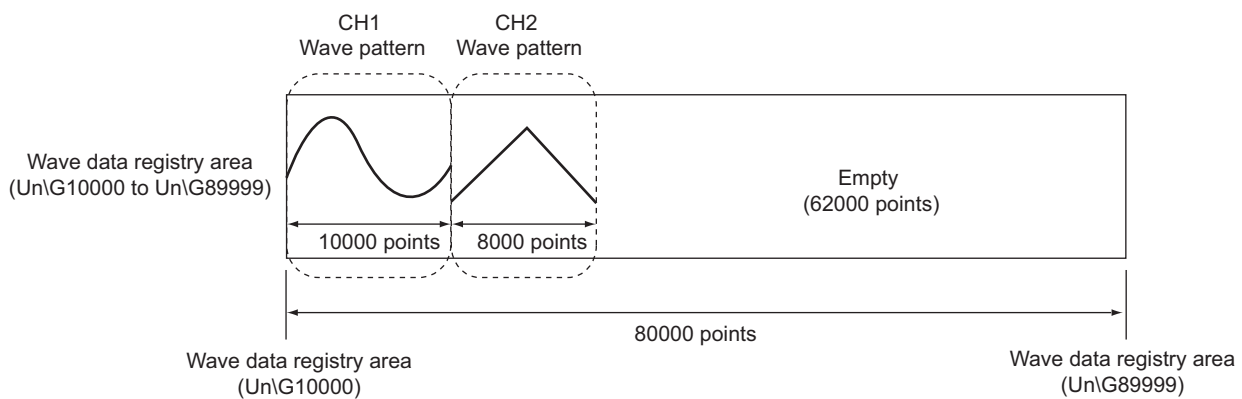

Setting item	Setting value
CH1 Wave pattern start address setting	10000
CH1 Wave pattern data points setting	10000
CH2 Wave pattern start address setting	20000
CH2 Wave pattern data points setting	8000

Ex.

Setting example to output the same waves from CH1 and CH2

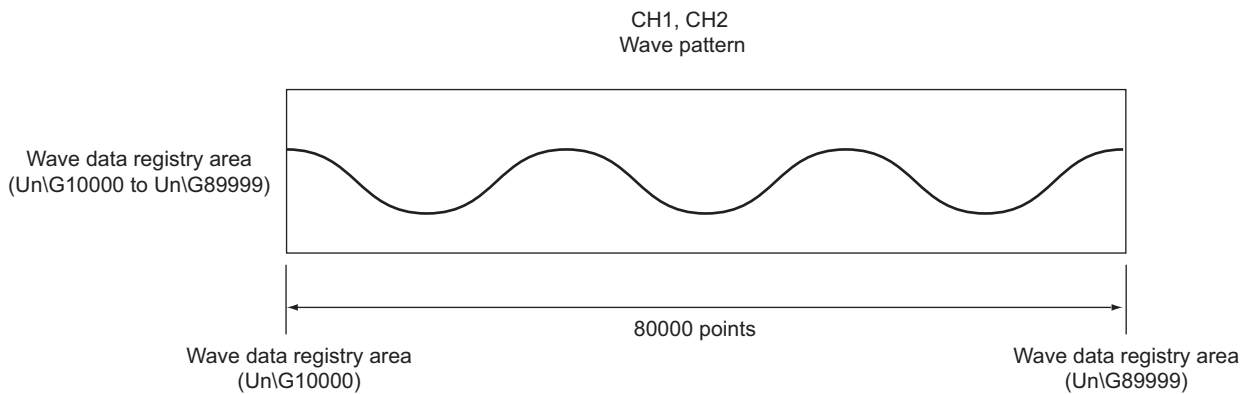

Setting item	Setting value
CH1 Wave pattern start address setting	10000
CH1 Wave pattern data points setting	80000
CH2 Wave pattern start address setting	10000
CH2 Wave pattern data points setting	80000

Wave pattern output count

The wave pattern can be output repeatedly according to the setting of 'CH1 Wave pattern output repetition setting' (Un\G530). Set the output count within 1 to 32767. The wave pattern also can be output in analog repeatedly and unlimitedly when -1 is set for the output count.

Ex.

When the wave pattern output count is set to three

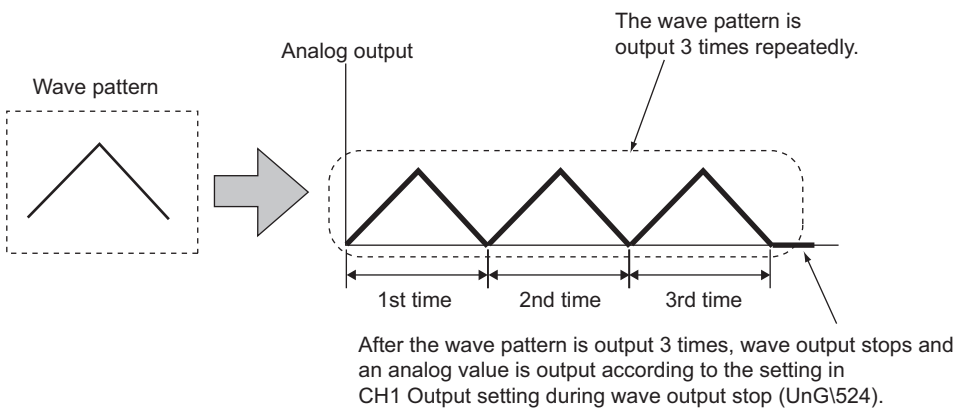

- Unlimited repetition

The digital input value of the wave pattern end point is not output in analog.

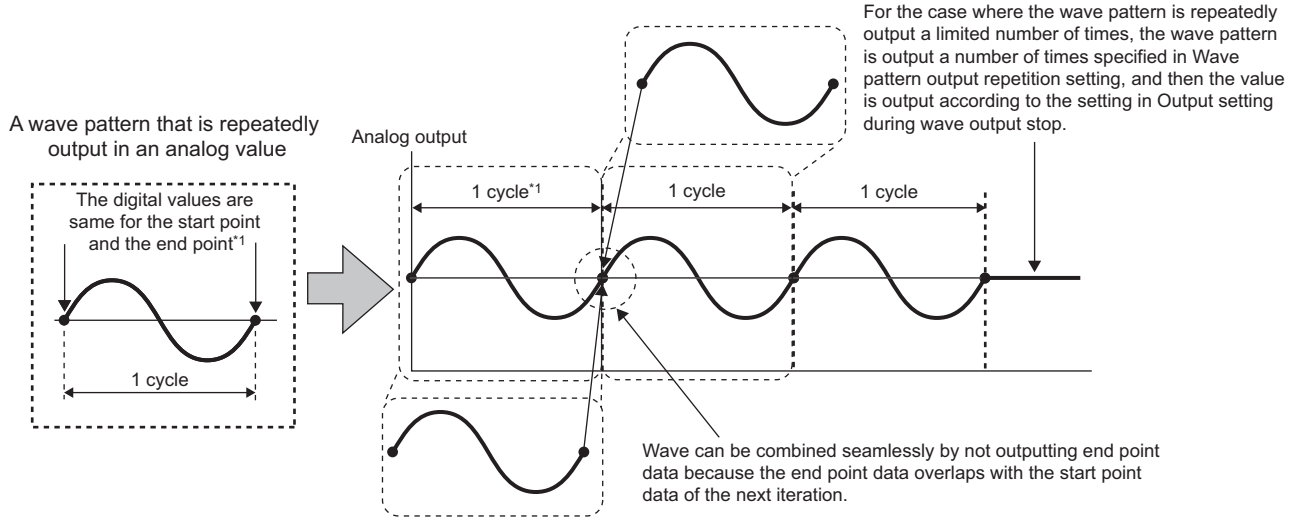

*1 The output cycle of a wave pattern is calculated by the following formula.
 Output cycle of a wave pattern = (Wave output conversion cycle) × (Wave pattern data points - 1)
 For details on the wave output conversion cycle, refer to the following.
 📖 Page 45 Wave output conversion cycle

Ex.

Calculating the output cycle of a wave pattern

Setting item	Setting value
CH1 D/A conversion enable/disable setting	D/A conversion enabled (0)
CH1 Wave pattern data points setting	101
CH1 Wave pattern output repetition setting	3
CH1 Constant for wave output conversion cycle	1

With the above setting, the output cycle of a wave pattern becomes as follows. (When the D/A conversion is enabled only for CH1)

$$\begin{aligned}
 \text{Output cycle of a wave pattern } (\mu\text{s}) &= \text{Conversion speed} \times \text{Number of channels where D/A conversion is enabled} \times \text{Constant for wave output conversion cycle} \times (\text{Wave pattern data points} - 1) \\
 &= 80 \times 1 \times 1 \times 100 \\
 &= \underline{8000}
 \end{aligned}$$

■When the digital input values are different between the start point and the end point

The wave pattern end point is output in analog as it is. The set wave patterns are continuously output in analog regardless of the setting in 'CH1 Wave pattern output repetition setting' (Un\G530).

A wave pattern that is repeatedly output in an analog value

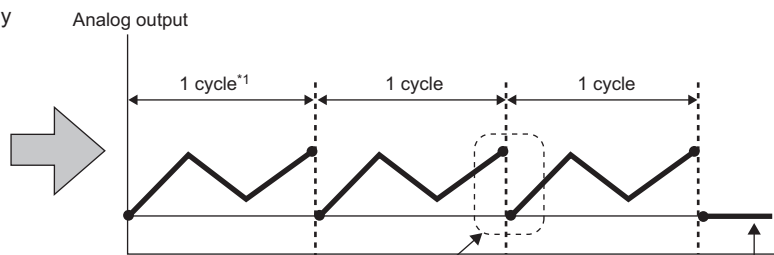
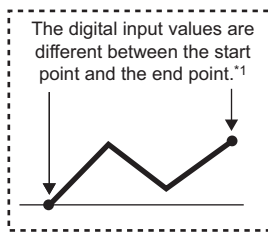

The digital input values of the end point and the start point of the next iteration are consecutively output in an analog value.

For the case where the wave pattern is repeatedly output a limited number of times, the wave pattern is output a number of times specified in Wave pattern output repetition setting, and then the value is output according to the setting in Output setting during wave output stop.

*1 The output cycle of a wave pattern is calculated by the following formula.

Output cycle of a wave pattern = (Wave output conversion cycle) × (Wave pattern data points)

For details on the wave output conversion cycle, refer to the following.

☞ Page 45 Wave output conversion cycle

Ex.

Calculating the output cycle of a wave pattern

Setting item	Setting value
CH1 D/A conversion enable/disable setting	D/A conversion enabled (0)
CH1 Wave pattern data points setting	101
CH1 Wave pattern output repetition setting	3
CH1 Constant for wave output conversion cycle	1

With the above setting, the output cycle of a wave pattern becomes as follows. (When the D/A conversion is enabled only for CH1)

$$\begin{aligned}
 \text{Output cycle of a wave pattern } (\mu\text{s}) &= \text{Conversion speed} \times \text{Number of channels where D/A conversion is enabled} \times \text{Constant for wave output conversion cycle} \times \text{Wave pattern data points} \\
 &= 80 \times 1 \times 1 \times 101 \\
 &= \underline{8080}
 \end{aligned}$$

Wave output conversion cycle

The wave output conversion cycle is calculated by the following formula.

$$\text{Conversion cycle } (\mu\text{s}) = \frac{\text{Conversion speed}}{(80\mu\text{s})} \times \text{Number of channels where D/A conversion is enabled} \times \boxed{\text{Constant for wave output conversion cycle}}$$

In the wave output function, the conversion cycle can be set by setting 'CH1 Constant for wave output conversion cycle' (Un\G531). The conversion cycle of the current output wave can be checked in 'CH1 Wave output conversion cycle monitor' (Un\G432, 433).

Ex.

The conversion cycle and operation timing

Setting item	Setting value
D/A conversion enable/disable setting	D/A conversion enabled (0) for CH1 to CH4
CH1 Constant for wave output conversion cycle	1
CH2 Constant for wave output conversion cycle	2
CH3 Constant for wave output conversion cycle	3
CH4 Constant for wave output conversion cycle	4

The following figure shows the conversion cycle of each channel with the above settings.



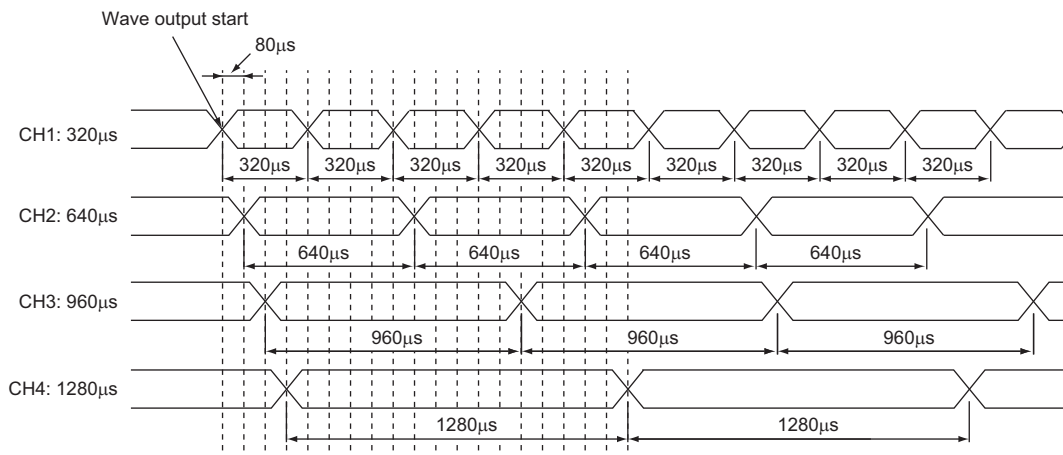

- CH1: 320 μs
- CH2: 640 μs
- CH3: 960 μs
- CH4: 1280 μs

D/A conversion is performed with this conversion cycle, and an analog value is output.



Initial settings of the wave output function

For the wave output function, set the following items as the initial setting. Before using the wave output function, complete the procedures described in this section.

- Creating wave data ( Page 46 Creating wave data)
- Setting parameters of the wave output function ( Page 49 Setting parameters of the wave output function)
- Writing wave output data to a file register (ZR) or CSV file ( Page 50 Writing data to a file register (ZR) or CSV file)
- Parameter setting of the D/A converter module ( Page 51 Parameter setting of the D/A converter module)

This section uses the R60DA4 for explanation.

Creating wave data

Create wave data on the "Create Wave Output Data" window of the engineering tool.

1. Start "Create Wave Output Data".

 [Tool] ⇒ [Module Tool List] ⇒ [Analog Output] ⇒ [Create wave output data]

2. Select "Module Type" in "R60DA4".

Restriction

If a type other than "Module Type" is selected, proper wave data cannot be created because the corresponding channel or the range of digital values differs.

In addition, "Wave pattern" and "Wave output data" are completely deleted by changing "Module Type". Therefore, set the correct value in "Module Type" and follow the procedure 3 or later.

3. Select the graph displayed in "Register wave pattern" and press the [Enter] key. The "Register Wave Pattern" window is displayed.
4. Set "Wave pattern information".

Item	Description	Setting range
Wave pattern No.	The wave pattern number selected in the "Create Wave Output Data" window is displayed. Up to 10 wave patterns can be created.	—
Wave pattern name	Set the name of the wave pattern.	16 characters
Digital value range	Select the setting range of the digital value according to the output range to be used.	• 0 to 32000 (default value) • -32000 to 32000
Number of data	Set the number of the digital values of the wave pattern.	1 to 80000 (default value: 100)
Comment	Set the comment of the wave pattern.	64 characters

5. Click any position on the wave graph to create an end point. The created end point is displayed with .

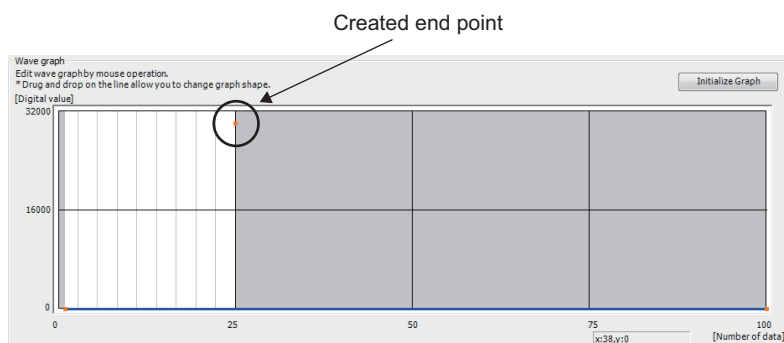

To delete the end point, move the mouse pointer to the point. Then select "Delete end point" from the right-click menu. When the mouse pointer is on the end point, the display of the mouse pointer is changed to \oplus .

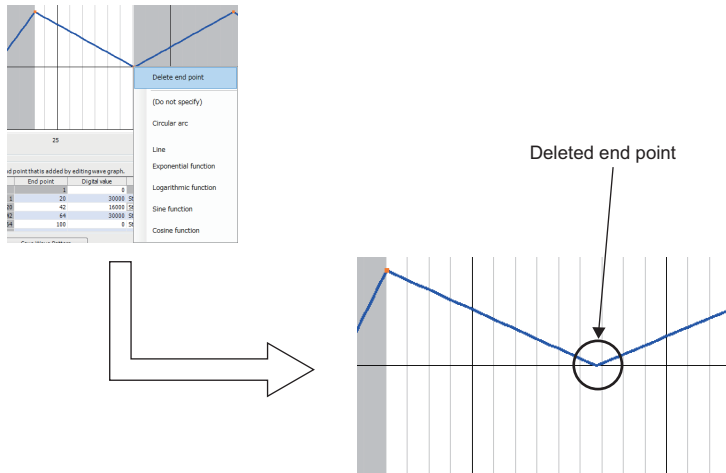

6. Set the wave between end points from the right-click menu or in "Specify wave" of "Wave details setting".

Item	Setting result												
Circular arc	<p>The interval of the start point and end point is drawn in an arc. When the circular arc is selected, the arc direction can be set in "Direction"; it can be inverted. The arc is drawn in the procedure below.</p> <div style="display: flex; align-items: center;"> <div style="flex: 1;"> <p>The arc to be drawn</p> <p>End point</p> <p>Start point</p> </div> <div style="flex: 1;"> <ol style="list-style-type: none"> 1) Construct an equilateral triangle having the start and end points as its vertices. 2) Construct a circle having the other vertex of the triangle as its center and a side of the triangle as its radius. 3) Draw the minor arc connecting the start and end points on the wave graph. <p>* The steps 1) and 2) are processed inside engineering tool, and not displayed on the wave graph.</p> </div> </div> <div style="display: flex; align-items: center; margin-top: 10px;"> <div style="flex: 1;"> <p>Set "Direction".</p> <table border="1" style="border-collapse: collapse; width: 100%;"> <thead> <tr> <th>Specify wave</th> <th>Direction</th> <th>Amplitude</th> </tr> </thead> <tbody> <tr> <td>Circular arc</td> <td>Upward</td> <td></td> </tr> <tr> <td>(Do not specify)</td> <td>Upward</td> <td></td> </tr> <tr> <td></td> <td>Downward</td> <td></td> </tr> </tbody> </table> </div> <div style="flex: 2;"> <div style="display: flex; justify-content: space-around; margin-bottom: 5px;"> In an upward direction In a downward direction </div> </div> </div>	Specify wave	Direction	Amplitude	Circular arc	Upward		(Do not specify)	Upward			Downward	
Specify wave	Direction	Amplitude											
Circular arc	Upward												
(Do not specify)	Upward												
	Downward												
Straight line	<p>The interval of the start point and end point is drawn in a straight line.</p>												
Exponential function	<p>The graph is drawn with an adjustment so that the start point and end point are on the edge points of the exponential function of $y = e^x$ ($x = 0$ to 10).</p>												

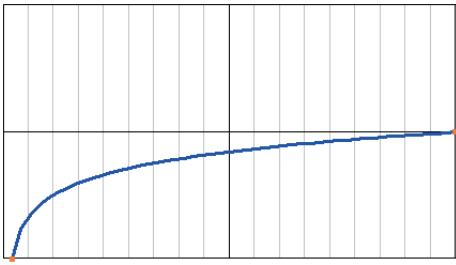
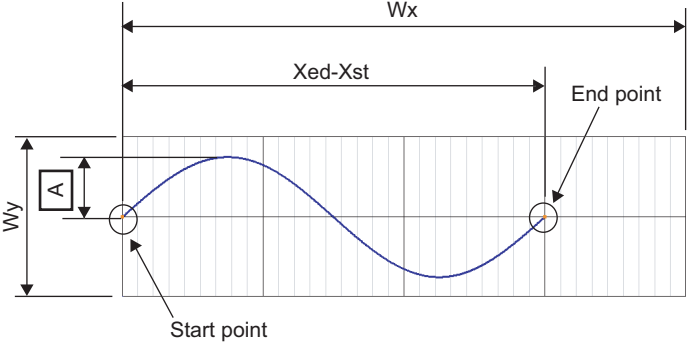
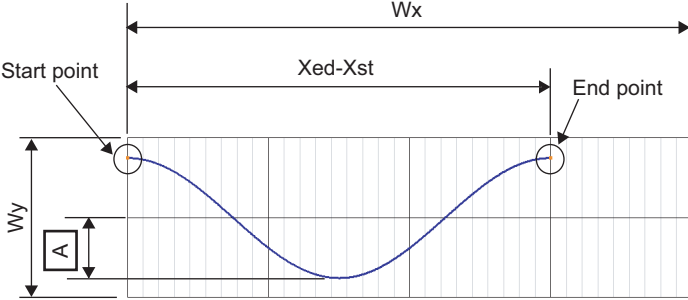
Item	Setting result
Logarithmic function	<p>The graph is drawn with an adjustment so that the start point and end point are on the edge points of the logarithmic function of $y = \log_e X$ ($X = 1$ to 101).</p> 
Sine function ^{*1}	<p>The interval between the start point and end point is drawn in a sine function wave. The amplitude A of the sine function to be drawn is the value set in "Amplitude". The start position can be changed by 180° by setting "Phase".</p>  <p>Number of data in a wave pattern: Wx Digital value range: Wy Data position of the start point: Xst Data position of the end point: Xed</p>
Cosine function ^{*1}	<p>The interval between the start point and end point is drawn in a cosine function wave. The amplitude A of the cosine function to be drawn is the value set in "Amplitude". The start position can be changed by 180° by setting "Phase".</p>  <p>Number of data in a wave pattern: Wx Digital value range: Wy Data position of the start point: Xst Data position of the end point: Xed</p>

*1 When using the sine function and cosine function, set the same digital value for the start point and end point.

7. Drag the created end point to adjust the position.

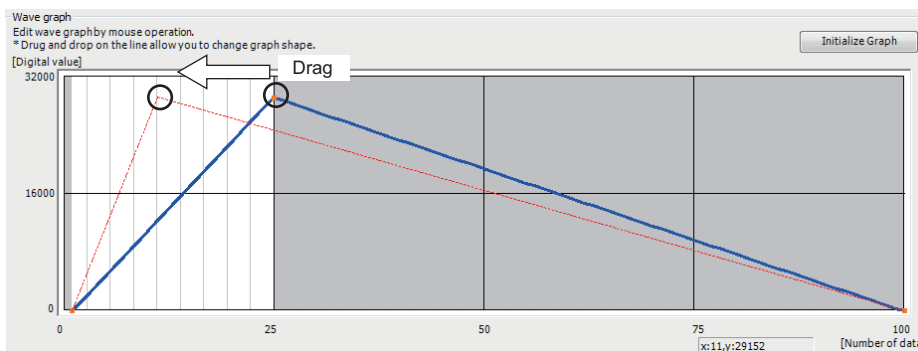

The end point position also can be adjusted by changing the value of "End point" and "Digital value" in "Wave details setting".

Item	Description
Start point	The end point of the previous interval is displayed. To change the start point, change the end point of the previous interval.
End point	Set the number of data (position) for the destination end point. Note that the section No.1 cannot be changed because it is the first point of the wave pattern.
Digital value	Set the digital value for the destination end point.

8. Repeat procedures 5 to 7 to create the wave to be output.

Each digital value of the created wave pattern can be checked by clicking the [Display Digital Value] button. Click the [Initialize Graph] button to clear the contents in the created wave pattern. The graph and the contents of "Wave details setting" are cleared.

9. Click the [Save Wave Pattern] button.

The saved wave pattern can be opened by clicking the [Open Wave Pattern] button.

10. Set the save destination and the file name, then click the [Save] button.

11. Click the [OK] button in the "Register Wave Pattern" window to register the created wave pattern.

12. Repeat procedures 3 to 12 to create other wave patterns.

Setting parameters of the wave output function

Set the parameters of the wave output function in the "Create Wave Output Data" window of the engineering tool. Before the parameter setting, create the wave data.

1. Start "Create Wave Output Data".

 [Tool] ⇒ [Module Tool List] ⇒ [Analog Output] ⇒ [Create wave output data]

2. Select "Module Type" in "R60DA4".

3. Set the parameters of the wave output function in "Wave output data setting".

Item	Description	Setting range
Wave pattern No.	Up to three patterns can be specified at a time from registered wave patterns. When specifying multiple wave patterns, set the pattern No. as follows. <ul style="list-style-type: none"> • When No. 1 to No. 2 are used: 1 and 2 • When No. 1, No. 5, and No. 10 are used: 1, 5, and 10 • When No. 1 to No. 3 are used: 1 to 3 	1 to 10
Output setting during wave output stop	Set the analog output during the wave output stop.	<ul style="list-style-type: none"> • 0: 0V/0mA • 1: Offset value (default value) • 2: Output value during wave output stop
Output value during wave output stop	Set the value to be output while the wave output is stopped. This setting is enabled only when "Output setting during wave output stop" is set to "2: Setting value during stop". Set the value within the output range to be used.	<ul style="list-style-type: none"> • 4 to 20mA, 0 to 20mA, 1 to 5V, 0 to 5V: 0 to 32767 (practical range: 0 to 32000) • -10 to 10V: -32768 to 32767 (practical range: -32000 to 32000)
Wave pattern start address setting	Set the start address of the wave pattern to be output in analog.	10000 to 89999 (default value: 10000)
Wave pattern data points setting	This setting is not required because the data points of the wave pattern to be used are stored automatically.	—
Wave pattern output repetition setting	This area is for setting the repeat count to output the wave pattern repeatedly.	<ul style="list-style-type: none"> • -1 (Unlimitedly repeat output) • 1 to 32767 (default value: 1)
Constant for wave output conversion cycle	Set the constant to determine the conversion cycle (specifying a multiple of the conversion speed). The conversion cycle of the wave output is determined from the combination of the conversion speed, number of channels where D/A conversion is enabled, and this setting. For the calculation method of the wave output conversion cycle, refer to the following.  Page 45 Wave output conversion cycle	1 to 5000 (default value: 1)

4. Click the [Save Wave Output Data to File] button.

The created wave pattern and the parameter setting of the wave output function are saved.

The saved wave pattern and parameter setting of the wave output function can be opened by clicking the [Open Wave Output Data from File] button.

Note that if the data created for the module type other than "R60DA4" is opened, the module type cannot be changed by setting "Module type" to "R60DA4".

5. Set the save destination and the file name, then click the [Save] button.

Writing data to a file register (ZR) or CSV file

Write the wave output data created using "Create wave output data" to a file register (ZR)^{*1} or a CSV file^{*2}.

These setting contents are registered to the buffer memory of the D/A converter module using the function block (FB) for the wave output data registration.

For details on the function block (FB) for the wave output data registration and wave output execution, refer to the following.

 MELSEC iQ-R Analog-Digital Converter Module/Digital-Analog Converter Module Function Block Reference

*1 The wave data and parameter setting contents remain in the CPU module even after the power-off or reset of the CPU module.

*2 The wave data and parameter setting can be used for the D/A converter module of other programmable controller systems only by copying the CSV file.

Point

- Data unnecessary for control such as "Wave pattern name", "Comment", and "Wave details setting" is not written to the file register (ZR) or a CSV file. Thus, saving the parameter settings of wave data and the wave output function using the [Save Wave Output Data to File] button before writing them is recommended.
- The settings of "Create Wave Output Data" cannot be written to the file register (ZR) with a project of the remote head module. Write the settings to a CSV file.

■ Writing data to a file register (ZR)

When writing the data to the file register (ZR), set the capacity of the file register (ZR) for the number of required data points.

For the setting procedure, refer to the following.

 MELSEC iQ-R CPU Module User's Manual (Application)

1. Click the [Write to Device Memory] button of the "Create Wave Output Data" window.
2. Set "Device memory name" and "Start device", then click the [OK] button.

Item	Description
Device memory name	Set the device memory to be written to the file register (ZR). Select the device memory to be written from the pull-down menu or enter the device memory name to be created.
Start device	Set the start address for the output of the device memory.
Target device to write to	The file register (ZR) range to write to is displayed.

3. Click the [Close] button in the "Create Wave Output Data" window to finish "Create Wave Output Data".
4. Write the device memory to the CPU module from "Write to PLC...".

 [Online] ⇄ [Write to PLC...]

■ Writing data to a CSV file

When writing the data to the CSV file, store the CSV file to an SD memory card.

1. Click the [Write to Device Memory] button of the "Create Wave Output Data" window.
2. Set the save destination and the file name, then click the [OK] button.
3. Click the [Close] button in the "Create Wave Output Data" window to finish "Create Wave Output Data".
4. Store the CSV file to an SD memory card. Then install the SD memory card to the CPU module.

Point

Some oscilloscopes or pulse generators can output the input wave or output wave to the CSV file. To output the wave with the wave output function by using the CSV file data, convert the data format into the one described in the following manual. In addition, convert the fractional value into the integer because the fractional value is unavailable in the wave output function.

 MELSEC iQ-R Analog-Digital Converter Module/Digital-Analog Converter Module Function Block Reference

Parameter setting of the D/A converter module

To use the wave output function, the module parameters are required in addition to the parameter setting of the wave output function.

The following shows the items set with the module parameters.

■Output range setting

"Output range setting" is the same as the one for the normal output. Select the output range to be used.

However, the user range cannot be used when the wave output function is used.

■Operation mode setting

Select "Normal mode (D/A conversion process)" in "Operation mode setting".

■Output mode setting

Select "Wave output mode" in "Output mode setting".

■Analog output HOLD/CLEAR setting

The operation of the analog output HOLD/CLEAR function for the normal output differs from the operation for the wave output. For the difference of the operations performed depending on the setting details of the HOLD/CLEAR setting, refer to the following.

 Page 20 Analog Output HOLD/CLEAR Function

■Alert output setting

Set "Alert output setting" for "Enable" of the channel where the D/A conversion is performed, as the normal output.

For the normal output, 'CH1 Digital value (Un\G460)' is the target. However, for the wave output, the set wave output data is the target.

Execution of the wave output function

This section describes the execution procedures for the wave output function. Execute the contents in this section after the initial setting of the wave output function.

Registering wave output data

Register the wave output data created with "Create Wave Output Data" of the engineering tool to the D/A converter module. Use the function block (FB) for the wave output data registration. For how to use the function block (FB) for the wave output data registration, refer to the following.

 MELSEC iQ-R Analog-Digital Converter Module/Digital-Analog Converter Module Function Block Reference

■When a remote head module is used

When the D/A converter module is mounted together with the remote head module, function blocks (FBs) cannot be used. For how to transfer the parameter settings of the wave data and the wave output function created with "Create Wave Output Data" of the engineering tool to the D/A converter module, refer to the following.

 Page 58 Registering data when the remote head module is used

D/A conversion enable/disable setting

Change the value of 'CH1 D/A conversion enable/disable setting' (Un\G500) using a program or a function block.

In this case, register the wave data settings and the parameter settings of the wave output function first, and then change the setting of D/A conversion enable/disable setting.

Precautions

D/A conversion enable/disable setting can also be set with the module parameters.

1. Set "D/A conversion enable/disable setting" to "Enable".

 Navigation window ⇒ [Parameter] ⇒ [Module Information] ⇒ Module name ⇒ [Module Parameter] ⇒ "Basic setting" ⇒ "D/A conversion enable/disable function"

When the setting is configured by the procedure described above, a wave pattern data points setting range error (error code: 1D5□H) occurs if the setting content is activated by resetting the CPU module or by turning off and on the power supply. This error occurs because the wave pattern data points setting is set to 0 (default value) for the channel where the D/A conversion is enabled.

To clear this error, register the wave output data and turn on and off 'Operating condition setting request' (Y9). ( Page 49 Setting parameters of the wave output function)

Changing the module setting

The contents registered by the function block (FB) for the wave output data registration need to be enabled by turning on and off 'Operating condition setting request' (Y9). When the setting is enabled, the analog output value of the channel 1 where the D/A conversion is enabled varies depending on the status of 'CH1 Output enable/disable flag' (Y1) as shown below.

- When 'CH1 Output enable/disable flag' (Y1) is off: The offset value is output.
- When 'CH1 Output enable/disable flag' (Y1) is on: The value set in 'CH1 Output setting during wave output stop' (Un\G524) is output.

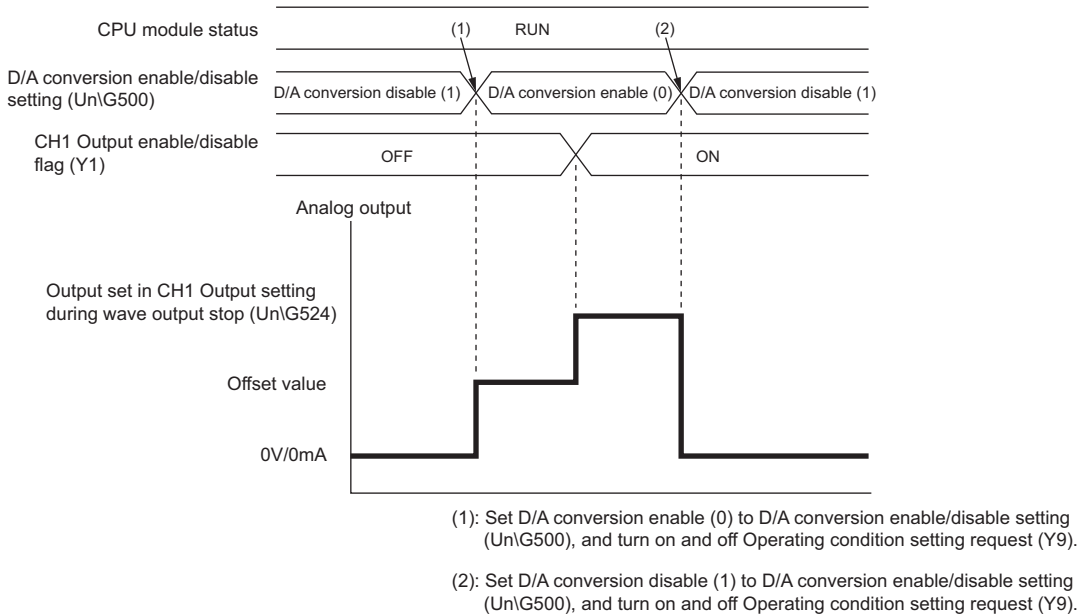

Point

With the wave output function being used, only when the wave output is stopped in all the channels (Wave output stop (0) is set to CH□ Wave output status monitor in all the channels), the parameter setting can be enabled by turning on and off 'Operating condition setting request' (Y9).

When 'Operating condition setting request' (Y9) is turned on and off with a channel being set to a value other than Wave output stop, an alert occurs. In addition, an alarm code (0B0□H) is stored in 'Latest alarm code' (Un\G2). The parameter setting cannot be enabled in this case.

Starting/stopping/pausing wave output

Starting the wave output

The wave output can be started by the following procedures after the wave data registration.

1. Turn on 'CH1 Output enable/disable flag' (Y1).

The value is output in analog according to the setting in 'CH1 Output setting during wave output stop' (Un\G524).

2. Set Wave output start request (1) to 'CH1 Wave output start/stop request' (Un\G462).

When Wave output stop request (0) or Wave output pause request (2) is changed to Wave output start request (1), the wave output is started.

Stopping the wave output

To stop the wave output at any timing during the wave output, set Wave output stop request (0) to 'CH1 Wave output start/stop request' (Un\G462). When Wave output start request (1) or Wave output pause request (2) is changed to Wave output stop request (0), the wave output is completely stopped. When the wave output is stopped, Wave output stop (0) is stored to 'CH1 Wave output status monitor' (Un\G401). The wave output cannot be resumed at the stop point.

When outputting the wave pattern for the count set in 'CH1 Wave pattern output repetition setting' (Un\G530) is finished, the wave output stops.

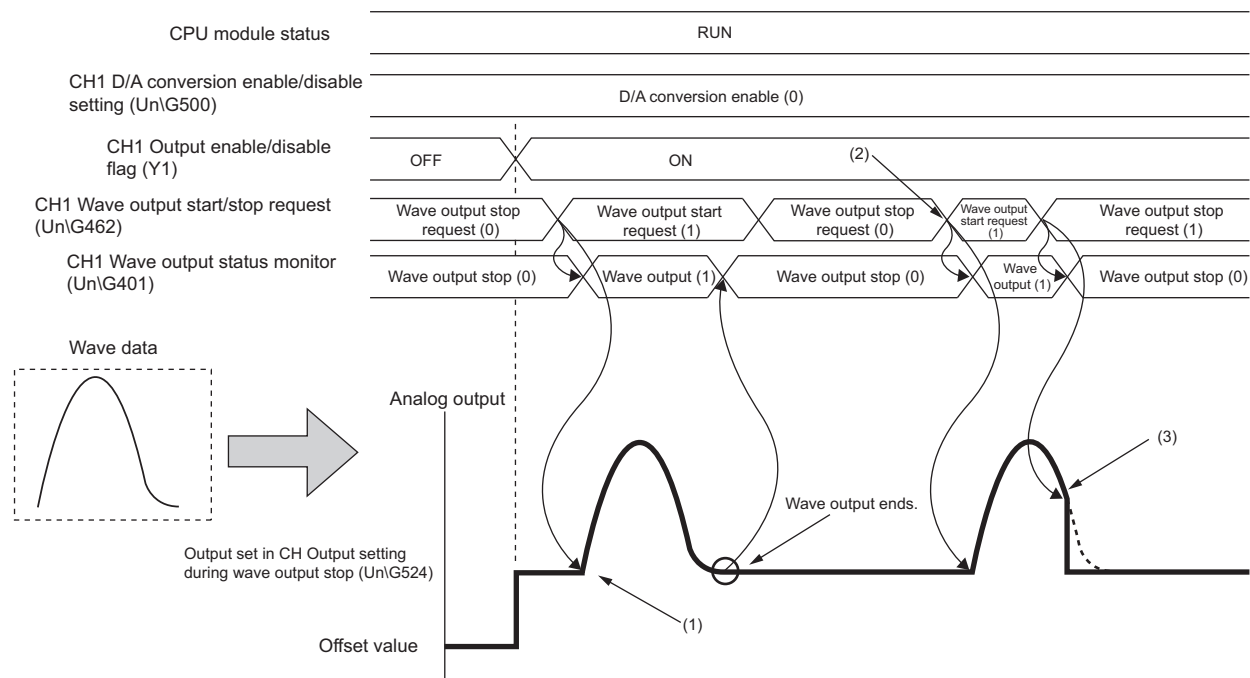

- (1): Wave output starts when Wave output start request (1) is set to CH1 Wave output start/stop request (Un\G462).
- (2): To execute wave output again, set Wave output stop request (0) to CH1 Wave output start/stop request (Un\G462), then change the value to Wave output start request (1).
- (3): Wave output stops when Wave output stop request (0) is set to CH1 Wave output start/stop request (Un\G462) during the wave output.

■Pausing the wave output

- To pause the wave output, set Wave output pause request (2) to 'CH1 Wave output start/stop request' (Un\G462). When Wave output start request (1) is changed to Wave output pause request (2), the wave output is paused. Wave output pause (2) is stored to 'CH1 Wave output status monitor' (Un\G401).
- To resume the wave output, change the value in 'CH1 Wave output start/stop request' (Un\G462) from Wave output pause request (2) to Wave output start request (1). The wave output is resumed from the paused point.
- When Wave output pause request (2) is set to 'CH1 Wave output start/stop request' (Un\G462) during the wave output stop, the digital input value of the wave pattern start address is output in analog after the D/A conversion.

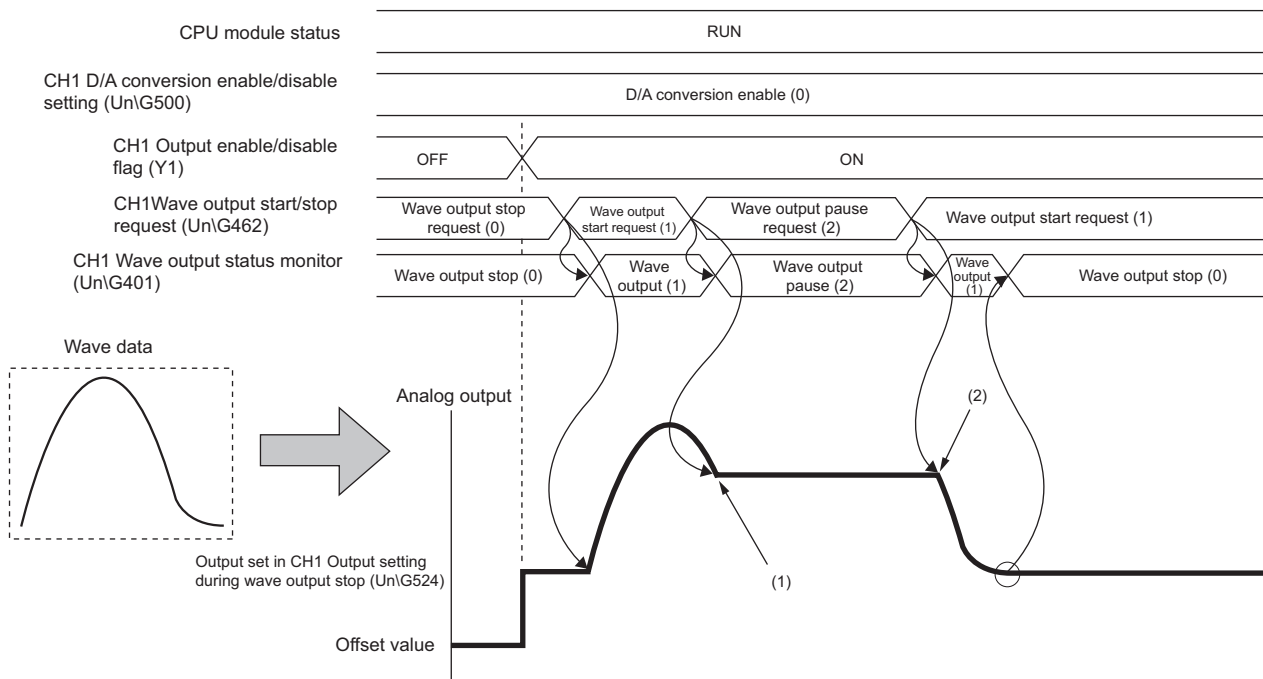

(1): Wave output pauses when Wave output pause request (2) is set to CH1 Wave output start/stop request (Un\G462) during the wave output.

(2): Wave output resumes when Wave output start request (1) is set to CH1 Wave output start/stop request (Un\G462) during the wave output pause.

The analog output value while the wave output is paused differs depending on the setting of the analog output HOLD/CLEAR function. For details, refer to the following.

☞ Page 20 In the wave output mode

• For HOLD setting

While the wave output is paused, analog output value during the pause is held.

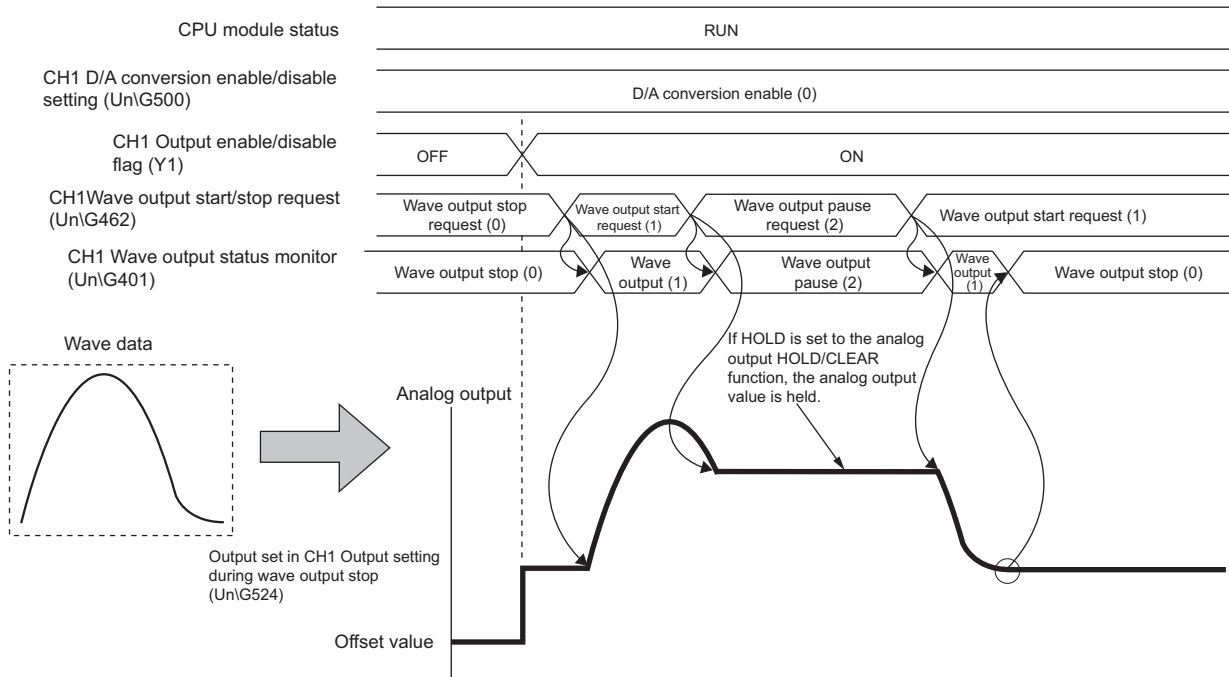

• For CLEAR setting

While the wave output is paused, the offset value is output.

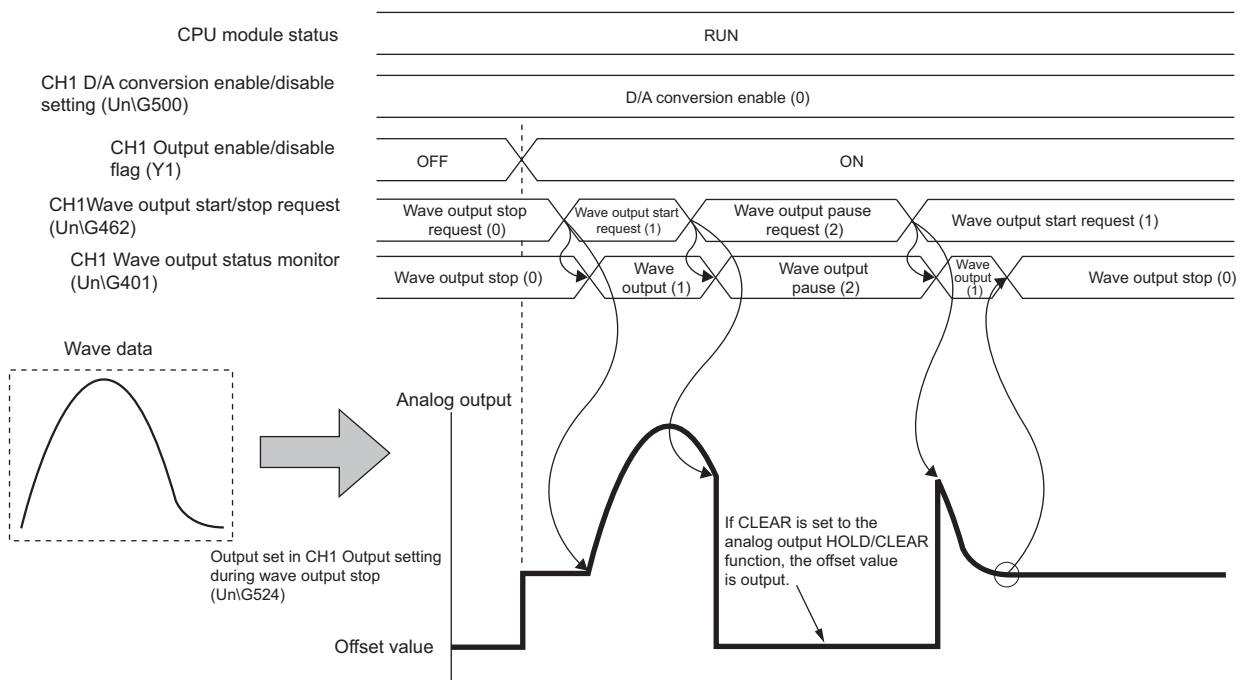

- Wave output start request is accepted only when the CPU module is in the RUN status. When a value in 'CH1 Wave output start/stop request' (Un\G462) is changed to Wave output start request (1) with the CPU module status other than in the RUN state, the wave output is not started.
- Wave output stop request is accepted when the CPU module is in the RUN or STOP status.
- Wave output pause request is accepted only when the CPU module is in the RUN status.
- When a value other than 0 to 2 is set to 'CH1 Wave output start/stop request' (Un\G462), an error occurs. The error code (1D0□H) is stored in 'Latest error code' (Un\G0), 'Error flag' (XF) turns on, and the ERR LED turns on. However, the process will continue.
- When a value out of the digital value range is set for the output range, a digital value setting range error (error code: 191□H) occurs.

Checking the setting for the wave output function

The setting for the wave output function can be checked in the following buffer memory areas.

Item	Description
Wave output status monitor	The wave output status is stored in this area.
Wave output conversion cycle monitor	The conversion cycle of the wave output is stored in 32-bit signed binary in this area. The unit of the stored value is μs .
Wave pattern output count monitor	The output count of the wave pattern is stored in this area.
Wave output current address monitor	The buffer memory address of the currently output wave data is stored in 32-bit signed binary in this area.
Wave output current digital value monitor	The digital input value which is being currently output is stored in this area.
Wave output digital value outside the range address monitor	When the wave data with the digital input value out of the setting range is output, the buffer memory address to register the wave data is stored in 32-bit signed binary in this area. When the multiple wave data with the digital input value out of the setting range are detected, only the buffer memory address of the wave data detected first is stored.
Wave output warning address monitor	The buffer memory address of the wave data where a warning has occurred is stored in 32-bit signed binary in this area. When a warning has occurred in the multiple wave data, only the buffer memory address of the wave data where the warning occurred first is stored.

For details on each buffer memory area, refer to the following.

 Page 136 Details of buffer memory addresses

Registering data when the remote head module is used

This section describes how to register the parameter settings of the wave data and the wave output function created with "Create Wave Output Data" of the engineering tool to the D/A converter module.

■Registering procedure

1. Use "Create Wave Output Data" of the engineering tool to write the parameter settings of the wave data and the wave output function to the file register (ZR) of the CPU module of the master station.
2. Use the JP.REMTOD instruction to transfer the parameter settings from the file register (ZR) to the D/A converter module mounted together with the remote head module.

In this case, register the parameter settings of the wave data and the wave output function first, and then change the setting of 'CH1 D/A conversion enable/disable setting' (Un\G500).

3. Perform operations such as requesting the start or stop of the wave output with a program.

■Program

The following describes a program that transfers the parameter settings from the file register (ZR) to the D/A converter module mounted together with the remote head module using the JP.REMTOD instruction. The program in this section is for the case when ZR0 is set as the start device and the parameter settings are written using "Create Wave Output Data". The file register (ZR) to which the parameter settings are written varies depending on the specified start device. For the file register (ZR) to which the settings are written, refer to the following.

📖 MELSEC iQ-R Analog-Digital Converter Module/Digital-Analog Converter Module Function Block Reference

- System configuration

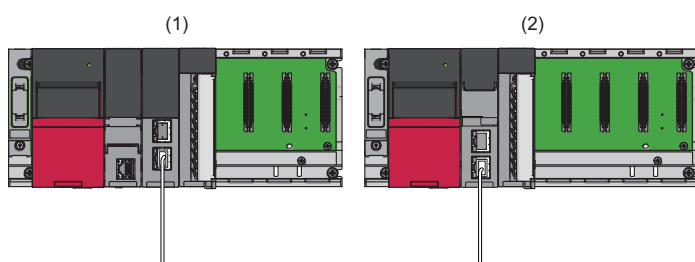

(1) Master station (Network number 1, station number 0)

- Power supply module: R61P
- CPU module: R04CPU
- Master/local module: RJ71GF11-T2 (Start I/O number: 0000H to 001FH)
- Input module: RX10 (Start I/O number: 0020H to 002FH)

(2) Intelligent device station (Network number 1, station number 1)

- Power supply module: R61P
- Remote head module: RJ72GF15-T2
- D/A converter module: R60DA4 (Start I/O number: 0000H to 000FH^{*1})

*1 In the RX/RX setting of the master station, set 1000H to 100FH as the start I/O number of the D/A converter module.

• Label setting

Classification	Label name	Description	Device
Module label	GF11_1.bSts_DataLinkError ^{*2}	Data link error status of host station	SB0049
	GF11_1.bnSts_DataLinkError_Station[1] ^{*2}	Data link status of each station (station No.1)	SW00B0.0

Labels to be defined

Define global labels as shown below:

	Label Name	Data Type	Class	Assign (Device/Label)
1	WaveOutputSettingRepeatCtrl	Bit	VAR_GLOBAL	M1 000
2	WaveOutputStpOutSelectStt	Bit	VAR_GLOBAL	M1 001
3	WaveOutputStpOutSelectComp	Bit	VAR_GLOBAL	M1 002
4	WaveOutputStpOutSelectErr	Bit	VAR_GLOBAL	M1 003
5	WaveOutputStpOutSelectOK	Bit	VAR_GLOBAL	M1 004
6	WaveOutputStpOutSettingStt	Bit	VAR_GLOBAL	M1 005
7	WaveOutputStpOutSettingComp	Bit	VAR_GLOBAL	M1 006
8	WaveOutputStpOutSettingErr	Bit	VAR_GLOBAL	M1 007
9	WaveOutputStpOutSettingOK	Bit	VAR_GLOBAL	M1 008
10	WavePatternTopAddressStt	Bit	VAR_GLOBAL	M1 009
11	WavePatternTopAddressComp	Bit	VAR_GLOBAL	M1 010
12	WavePatternTopAddressErr	Bit	VAR_GLOBAL	M1 011
13	WavePatternTopAddressOK	Bit	VAR_GLOBAL	M1 012
14	WavePatternNumStt	Bit	VAR_GLOBAL	M1 013
15	WavePatternNumComp	Bit	VAR_GLOBAL	M1 014
16	WavePatternNumErr	Bit	VAR_GLOBAL	M1 015
17	WavePatternNumOK	Bit	VAR_GLOBAL	M1 016
18	WaveOutputCntStt	Bit	VAR_GLOBAL	M1 017
19	WaveOutputCntComp	Bit	VAR_GLOBAL	M1 018
20	WaveOutputCntErr	Bit	VAR_GLOBAL	M1 019
21	WaveOutputCntOK	Bit	VAR_GLOBAL	M1 020
22	WaveOutputConnCircleStt	Bit	VAR_GLOBAL	M1 021
23	WaveOutputConnCircleComp	Bit	VAR_GLOBAL	M1 022
24	WaveOutputConnCircleErr	Bit	VAR_GLOBAL	M1 023
25	WaveOutputConnCircleOK	Bit	VAR_GLOBAL	M1 024
26	WaveDataWriteRequest	Bit	VAR_GLOBAL	M1 025
27	WaveDataWriteComp	Bit	VAR_GLOBAL	M1 026
28	WaveDataWriteErr	Bit	VAR_GLOBAL	M1 027
29	WaveDataWriteRepeatCtrl	Bit	VAR_GLOBAL	M1 028
30	WaveOutputSettingRequest	Bit	VAR_GLOBAL	X24
31	WaveDataWriteFinalOK	Bit	VAR_GLOBAL	M1 030
32	Connect_FormationFlg_St1	Bit	VAR_GLOBAL	M0
33	WaveDataIndex	Double Word [Unsigned]/Bit String [32-bit]	VAR_GLOBAL	L20
34	BufMemoryAddressIndex	Word [Signed]	VAR_GLOBAL	Z0
35	WaveOutputSettingIndex	Word [Signed]	VAR_GLOBAL	Z1
36	Nesting_St1	Word [Signed]	VAR_GLOBAL	N0

*2 This label is a module label of the master/local module (RJ71GF11-T2). For the details, refer to MELSEC iQ-R CC-Link IE Field Network User's Manual (Application).

Points to use the wave output function

When CH1 Output enable/disable flag (Y1) is turned on or off during the wave output

When 'CH1 Output enable/disable flag' (Y1) is turned on and off during the wave output, the analog output value becomes the offset value and the wave output does not stop. The wave output continues to be updated while 'CH1 Output enable/disable flag' (Y1) is off. When 'CH1 Output enable/disable flag' (Y1) is turned off and on, the analog output restarts.

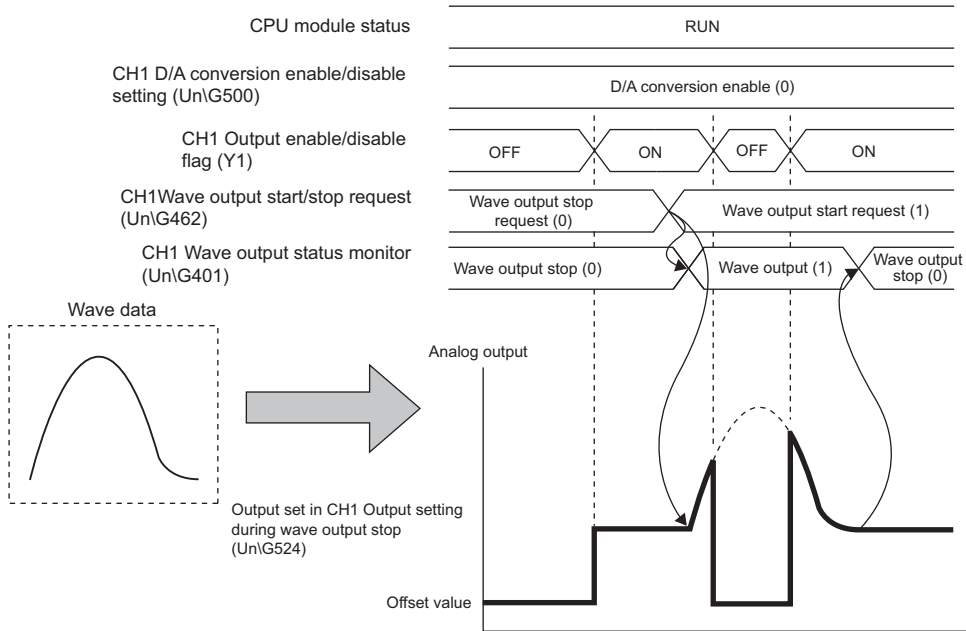

When changing the CPU module status during the wave output

When the CPU module status is changed during the wave output, the operation of the module varies depending on the setting of the analog output HOLD/CLEAR function as shown below.

■For HOLD setting

When the CPU module status is changed from RUN to STOP, the analog output value at the change is held and the wave output pauses. When the CPU module status is changed from STOP to RUN, the wave output resumes. To prevent the wave output from resuming, set Wave output stop request (0) to 'CH1 Wave output start/stop request' (Un\G462) after changing the CPU module status from RUN to STOP.

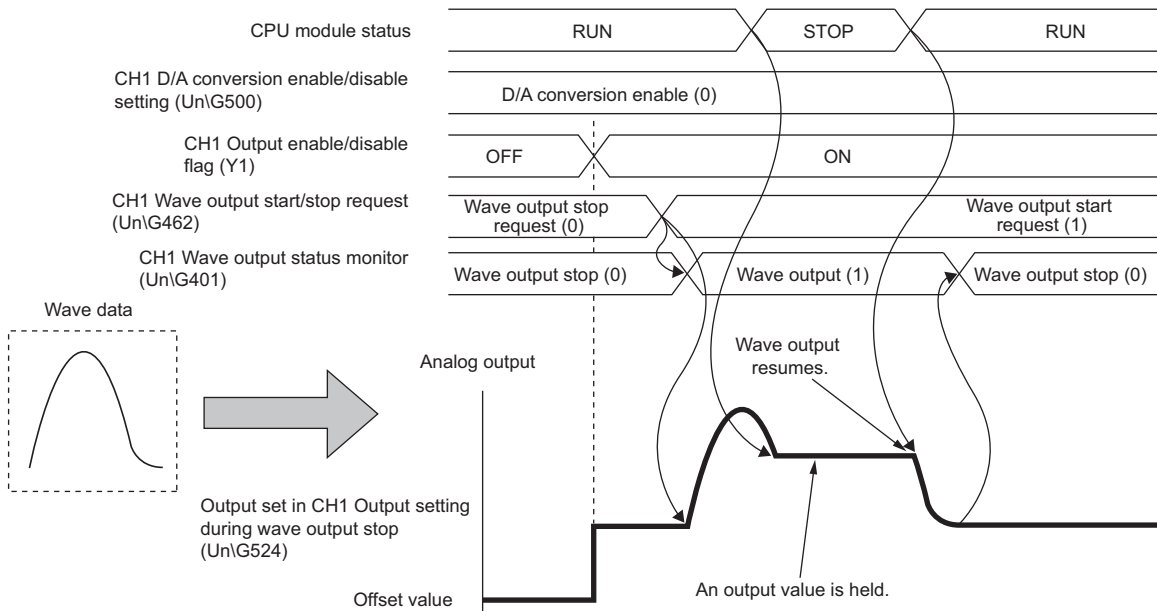

Precautions

At the timing when the CPU module status is changed from STOP to RUN, the module parameter setting is reflected.

At this time, the same processing as the one when 'Operating condition setting request' (Y9) is turned on and off in the D/A converter module is executed. Therefore, if the CPU module status is changed from STOP to RUN while 'CH1 Wave output status monitor' (Un\G462) is in a state other than Wave output stop (0), an operating condition setting error except for wave output stop (alarm code: 0B0□H) occurs.

To clear the alarm, turn on and off 'Alert output clear request' (YE).

■For CLEAR setting

When the CPU module status is changed from RUN to STOP, the wave output is finished and the offset value is output. When the CPU module status is changed from STOP to RUN, the value is output according to the setting in 'CH1 Output setting during wave output stop' (Un\G524). The wave output does not resume.

To execute the wave output again, set Wave output stop request (0) to 'CH1 Wave output start/stop request' (Un\G462) after changing the CPU module status from STOP to RUN. Then, change the value in 'CH1 Wave output start/stop request' (Un\G462) from Wave output stop request (0) to Wave output start request (1).

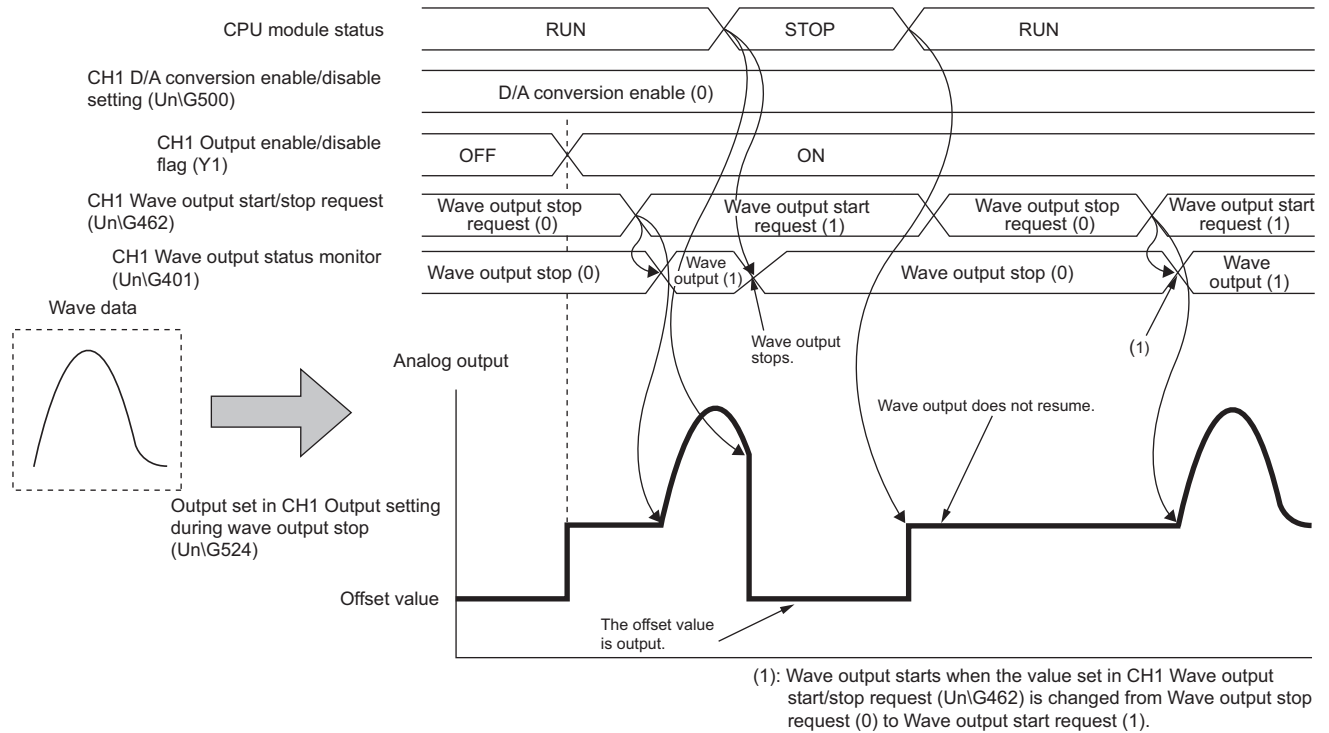

When an error occurs

When the value to be output is out of the output range, an error occurs. The error code (191□H) is stored in 'Latest error code' (Un\G0), 'Error flag' (XF) turns on, and the ERR LED turns on. When an error (error code: 191□H) occurs during the wave output, the analog output value becomes as follows.

- If the value to be output is greater than the maximum value of the output range, the maximum value of the output range is output in analog.
- If the value to be output is smaller than the minimum value of the output range, the minimum value of the output range is output in analog.

When an error (error code: 191□H) has occurred, correct the digital input value of the wave data so that the value is within the output range. Then, turn on and off 'Error clear request' (YF).

When 0 to 5V is set to the output range

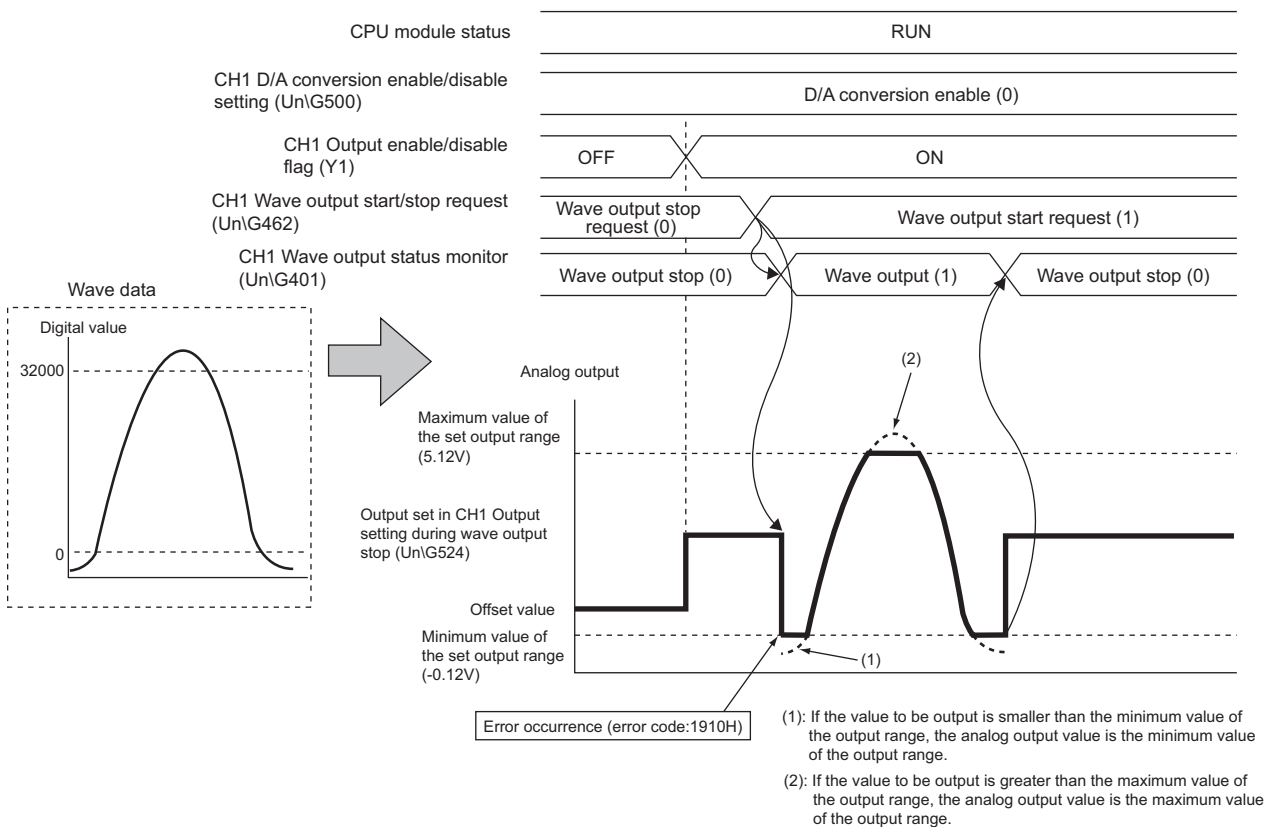

In addition, when the digital input value out of the range is set and an error (error code: 191□H) has occurred, correct the value to the one within the range and turn on and off 'Error clear request' (YF).

To check the buffer memory address where the wave data with the value out of the range is registered, use Wave output digital value out-of-range address monitor.

When the external power supply is turned off during the wave output

When the external power supply is turned off during the wave output, the wave output status of all the channels becomes the wave output stop (the wave output stops). The wave output does not resume even when the external power supply is turned on.

To resume the wave output, check the D/A converter module and external devices after turning on the external power supply, and set Wave output start request (1) to 'CH1 Wave output start/stop request' (UnG462).

Wave output start/stop request cannot be accepted when the external power supply is off.

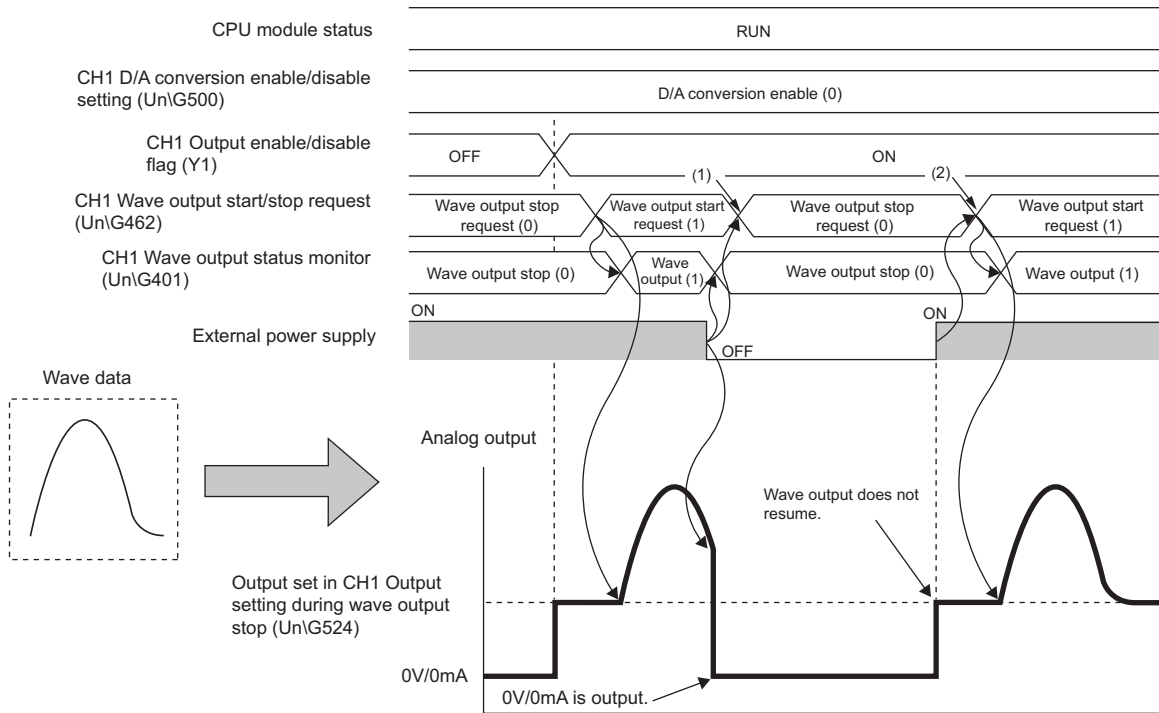

(1): Because the external power supply was turned off and wave output stopped, change the value set in CH1 Wave output start/stop request (UnG462) to Wave output stop request.

(2): To resume wave output, change the value set in CH1 Wave output start/stop request (UnG462) from Wave output stop request (0) to Wave output start request (1).

When using the wave output function as PWM

The wave output function can also be used as PWM with the minimum pulse width of 80 μ s.

Also the man-hours for programming can be reduced because necessary numbers of pulses can be output in analog by creating a wave pattern only for one pulse.

■Wave pattern example

When a wave pattern with pulse width of 80 μ s, amplitude of 5V, and duty ratio of 50% is created

1. Set "Output range setting" to "0 to 5V".

Navigation window \Rightarrow [Parameter] \Rightarrow [Module Information] \Rightarrow Module name \Rightarrow [Module parameter] \Rightarrow "Basic setting" \Rightarrow "Range switching function"

2. Create a wave pattern for one pulse in "Create Wave Output Data".

Setting item	Setting content	
Wave pattern information	Digital value range	0 to 32000
	Number of data	2
Wave details setting	Digital value for Section No.1	32000
	Digital value for Section No.2	0
	Specify wave for Section No.2	Straight line

The wave pattern to be output in analog differs from the one to be monitored on the engineering tool.

3. Configure "Create Wave Output Data" as shown below.

Setting item	Setting content
Wave pattern No. for CH1	Wave pattern created in step 2
CH1 Wave pattern start address setting	5000 (default value)
CH1 Wave pattern output repetition setting	Set the number of repetitions.
CH1 Constant for wave output conversion cycle	1 (default value)

4. Register the wave data and parameters of the wave output function to the D/A converter module. For how to register the wave data and parameters, refer to the following.

Page 52 Registering wave output data

5. Set 'CH1 D/A conversion enable/disable setting' (Un\G500) to D/A conversion enabled (0).
6. Turn on and off 'Operating condition setting request' (Y9).
7. Turn on 'CH1 Output enable/disable flag' (Y1).
8. Start the wave output by setting Wave output start request (1) to 'CH1 Wave output start/stop request' (Un\G462). Then the values are output in analog as shown below.

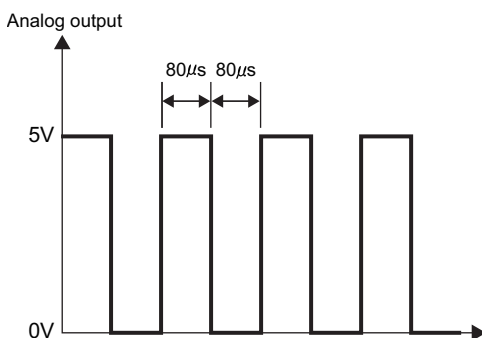

Wave output step action function

This function changes addresses and data values to be output to change the analog output flexibly at any timing when the wave output function is used.

This function is useful for the analog output test when the wave output function is used and for debugging the wave output function.

Ex.

Wave output step action on the following conditions

- The output range is set to -10 to 10V.
- The wave output status is the wave output.
- The address of when the step action wave output request is accepted is 34990.

1 Set ON (1) to Step action wave output request (Un\G188) during the wave output.

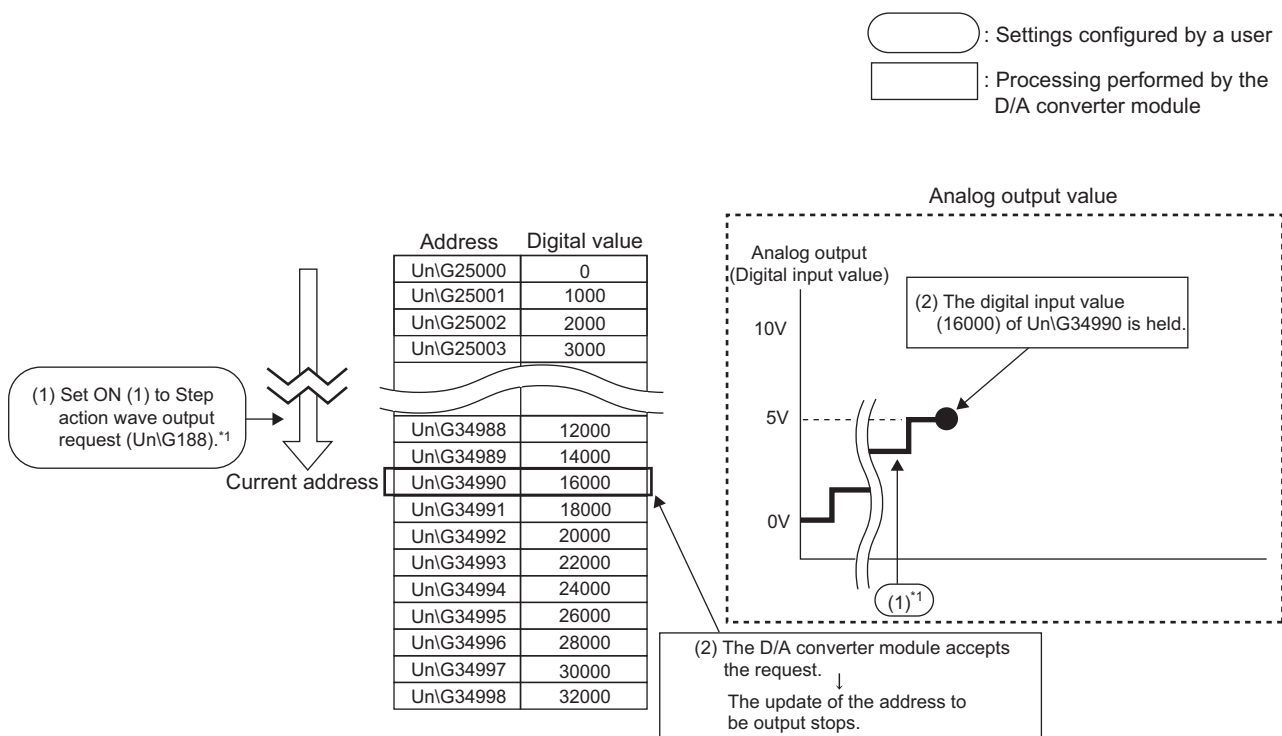

*1 The contents described here is the case when the wave output status is the wave output at the timing of (1). If the wave output status is the status other than the wave output, following operations are performed at the timing of (2).

- When the wave output status is the wave output stop
The digital input value of the address set as the wave pattern start address is output in an analog value and held.
- When the wave output status is the wave output pause
The data of the address during the wave output pause (wave output current address) is held.

2 Set 8 (8 in the forward direction) to CH1 Wave output step action movement amount (Un\G482).

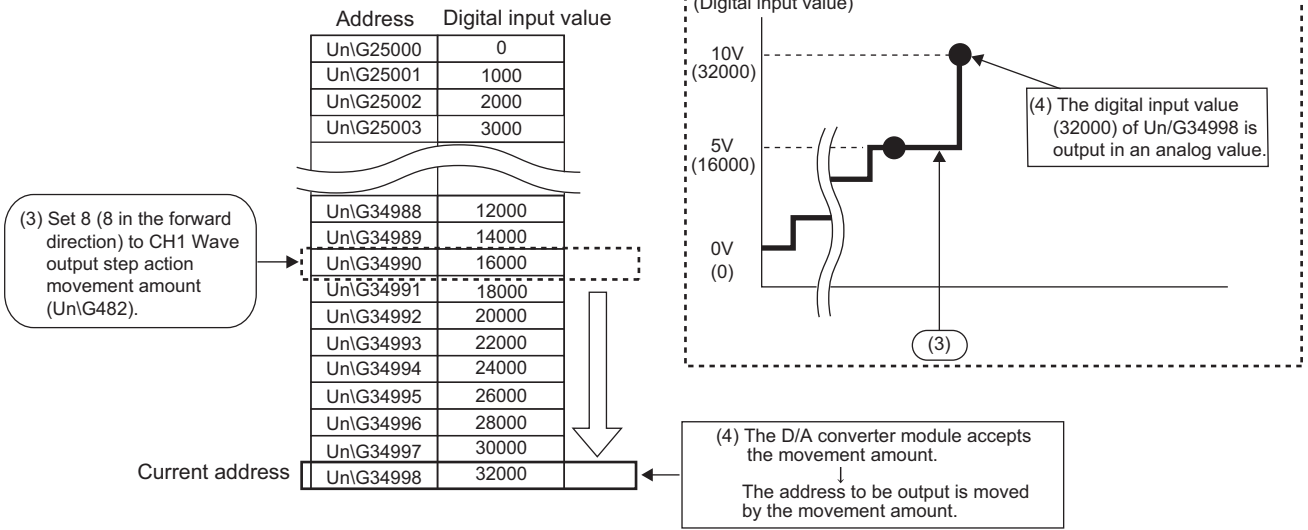

3 Change the digital input value (in the address 34992) to 8000, and set -6 (6 in the reverse direction) to CH1 Wave output step action movement amount (Un\G482).

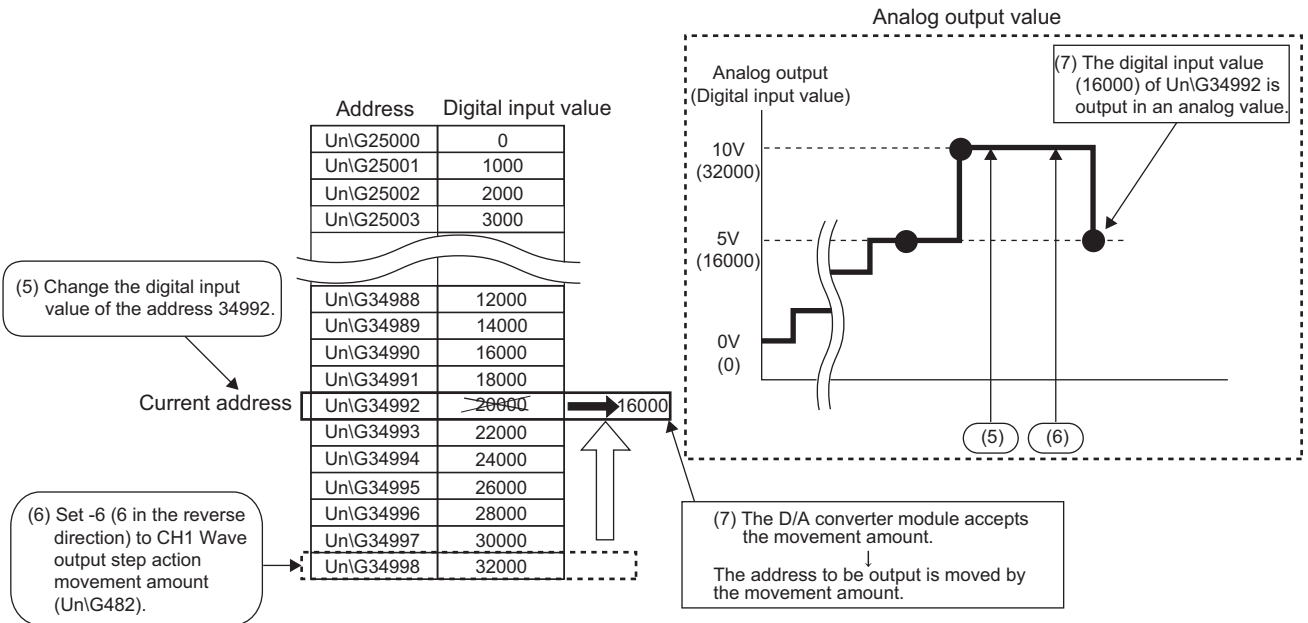

4 Set OFF (0) to Step action wave output request (Un\G188).

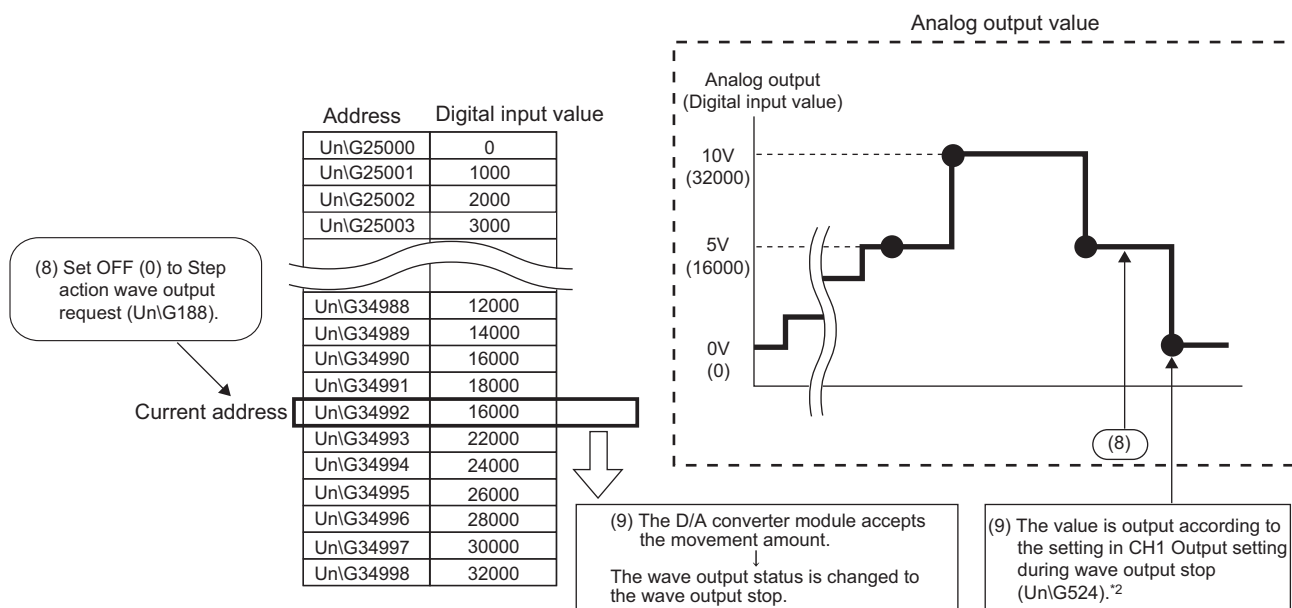

*2 This graph shows the value when 0V/0mA (0) is set to CH1 Output setting during wave output stop (Un\G524).

Operation of the wave output step action function

The wave output step action function is executed as follows.

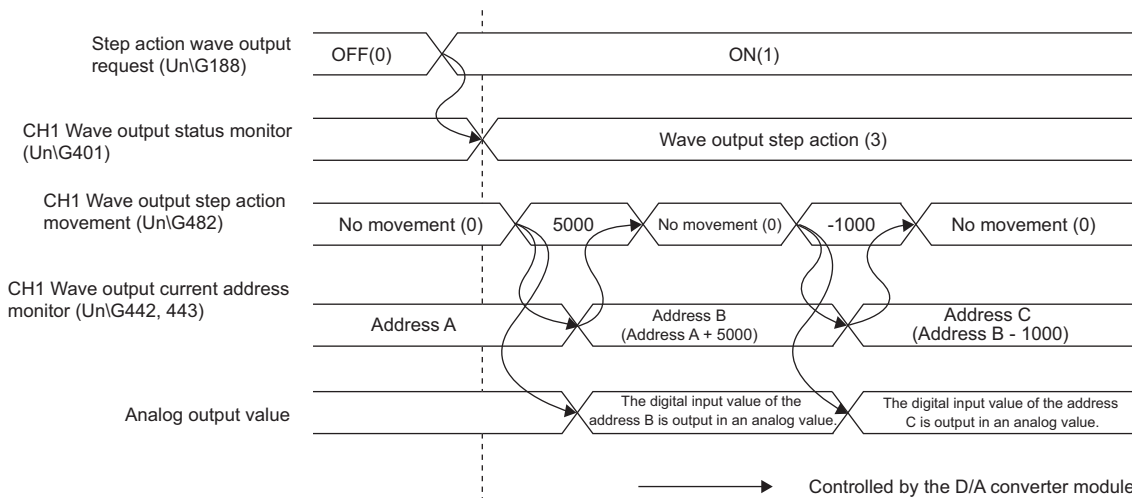

Change the value in 'Step action wave output request' (UnG188) from OFF (0) to ON (1) to set the wave output status to the wave output step action. By setting a value in 'CH1 Wave output step action movement amount' (UnG482) during the wave output step action, the address moves to the address of the target wave data for the output test. Set the amount for movement from the current wave data address in 'CH1 Wave output step action movement amount' (UnG482).

After the movement, the value in 'CH1 Wave output step action movement amount' (UnG482) is changed to No movement (0) and the wave data of the target address is output in analog.

The available range for movement by using 'CH1 Wave output step action movement amount' (UnG482) depends on the setting values of the wave pattern start address and wave pattern data points. The following shows the available range for movement.

$$\left(\begin{array}{l} \text{Wave pattern} \\ \text{start address} \end{array} \right) \text{ to } \left(\begin{array}{l} \text{Wave pattern} \\ \text{start address} \end{array} + \begin{array}{l} \text{Wave pattern} \\ \text{data points} \end{array} - 1 \right)$$

If a value out of the setting range of the wave pattern data points is set to 'CH1 Wave output step action movement amount' (UnG482), the data is processed with the value within the setting range.

Execution of the wave output step action function

To use the wave output step action function, the initial setting for the wave output function must be set in advance. For details on the initial setting for the wave output function, refer to the following.

☞ Page 46 Initial settings of the wave output function

■ Switch to the wave output step action status

Switch the wave output status to the wave output step action in the following procedure.

1. Change the value in 'Step action wave output request' (UnG188) from OFF (0) to ON (1).
2. Check that During wave output step action (3) has been set to CH□ Wave output status monitor in all the channels where the D/A conversion is enabled.

To execute the wave output step action, check 'Latest error code' (UnG0) and the ERR LED to check that no error has occurred, and set 'Step action wave output request' (UnG188) from OFF(0) to ON(1). When the value in the parameter setting of the wave output is not set within the setting range in all the channels where the D/A conversion is enabled, the wave output step action cannot be executed in all the channels.

■Execution of the wave output step action

After switching the status to the wave output step action status, execute the wave output step action in the following procedure. Repeating this procedure tests the analog output during the wave output function execution and debugs the wave output function.

1. Change the value of the target wave data for the wave output step action to any value.
2. Set a value to 'CH1 Wave output step action movement amount' (Un\G482).

Set the following value according to the direction to move.

Movement direction	Description	Setting value
No movement	The buffer memory address of the wave data to be output is not moved.	0
Forward movement	The buffer memory address of the wave data to be output is moved in the address increasing direction from the buffer memory address of the currently output wave data. ■When 10000 is set in 'CH1 Wave output step action movement amount' (Un\G482) with the buffer memory address of the currently output wave data being Un\G20000 The buffer memory address of the wave data to be output is changed to Un\G30000.	1 to 30000
Reverse movement	The buffer memory address of the wave data to be output is moved in the address decreasing direction from the buffer memory address of the currently output wave data. ■When -10000 is set in 'CH1 Wave output step action movement amount' (Un\G482) with the buffer memory address of the currently output wave data being Un\G40000 The buffer memory address of the wave data to be output is changed to Un\G30000.	-1 to -30000

3. Check that the value in 'CH1 Wave output step action movement amount' (Un\G482) became No movement (0).
4. Check that 'CH1 Wave output current address monitor' (Un\G436, Un\G437) are the buffer memory addresses of the wave data to be output.
5. Check that proper analog values are output.

■End of the wave output step action

End the wave output step action in the following procedure.

1. Change the value in 'Step action wave output request' (Un\G188) from ON (0) to OFF (1).
2. Check that Wave output stop (0) has been set to CH□ Wave output status monitor in all the channels. If a value other than Wave output stop request (0) has been set to CH□ Wave output start/stop request, the value is changed to Wave output stop request (0) forcibly at this timing. Check also the value of this buffer memory area.

To execute the wave output after the wave output step action, set Wave output start request (1) to CH□ Wave output start/stop request.

Point

- Analog output may be changed suddenly when a value is set to CH□ Wave output step action movement amount. To prevent a sudden change, use of CH□ Wave output step action movement amount in combination with CH□ Output enable/disable flag is recommended. For the combination, refer to the following.
 - ☞ Page 20 In the wave output mode
- An analog output can be changed at any timing as well by using CH□ Wave output step action movement amount in combination with CH□ Output enable/disable flag during the wave output step action. For details, refer to the following.
 - ☞ Page 75 Analog output test when the wave output function is used
- During the wave output step action, the wave output status is not changed even when a value is set to CH□ Wave output start/stop request. To change the wave output status, set OFF (0) to 'Step action wave output request' (Un\G188) (set the status to the wave output stop).

Analog output test when the wave output function is used

The following shows the procedure of the analog output test using the wave output step action function.

The example of testing analog output in CH1 is described as well.

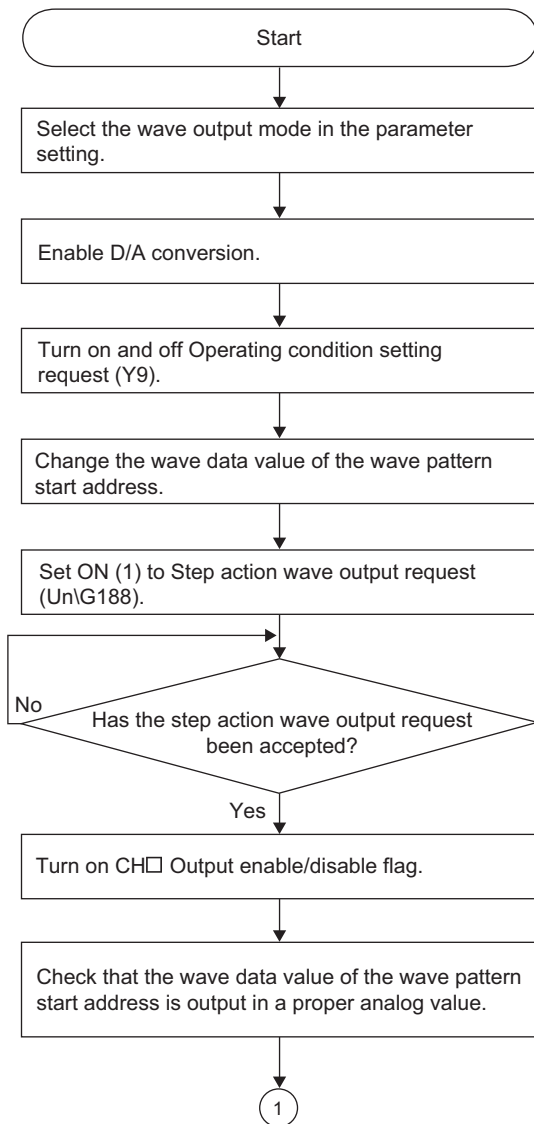

Example of testing analog output in CH1

Select "Wave Output Function" for "Output mode setting" in the parameter setting.

Set CH1 D/A conversion enable/disable setting (UnG500) to D/A conversion enable (0).

Turn on and off Operating condition setting request (Y9).
Even though the D/A conversion is enabled, the analog output value is the offset value because CH1 Output enable/disable flag (Y1) is off.

The value set in CH1 Wave output status monitor (UnG401) is changed to Wave output step action (3) when the value in Step action wave output request (UnG188) has been accepted.

The analog output value changes from the offset value to the wave data value of the wave pattern start address.

Check that the analog output value is proper using a measuring instrument such as a tester.

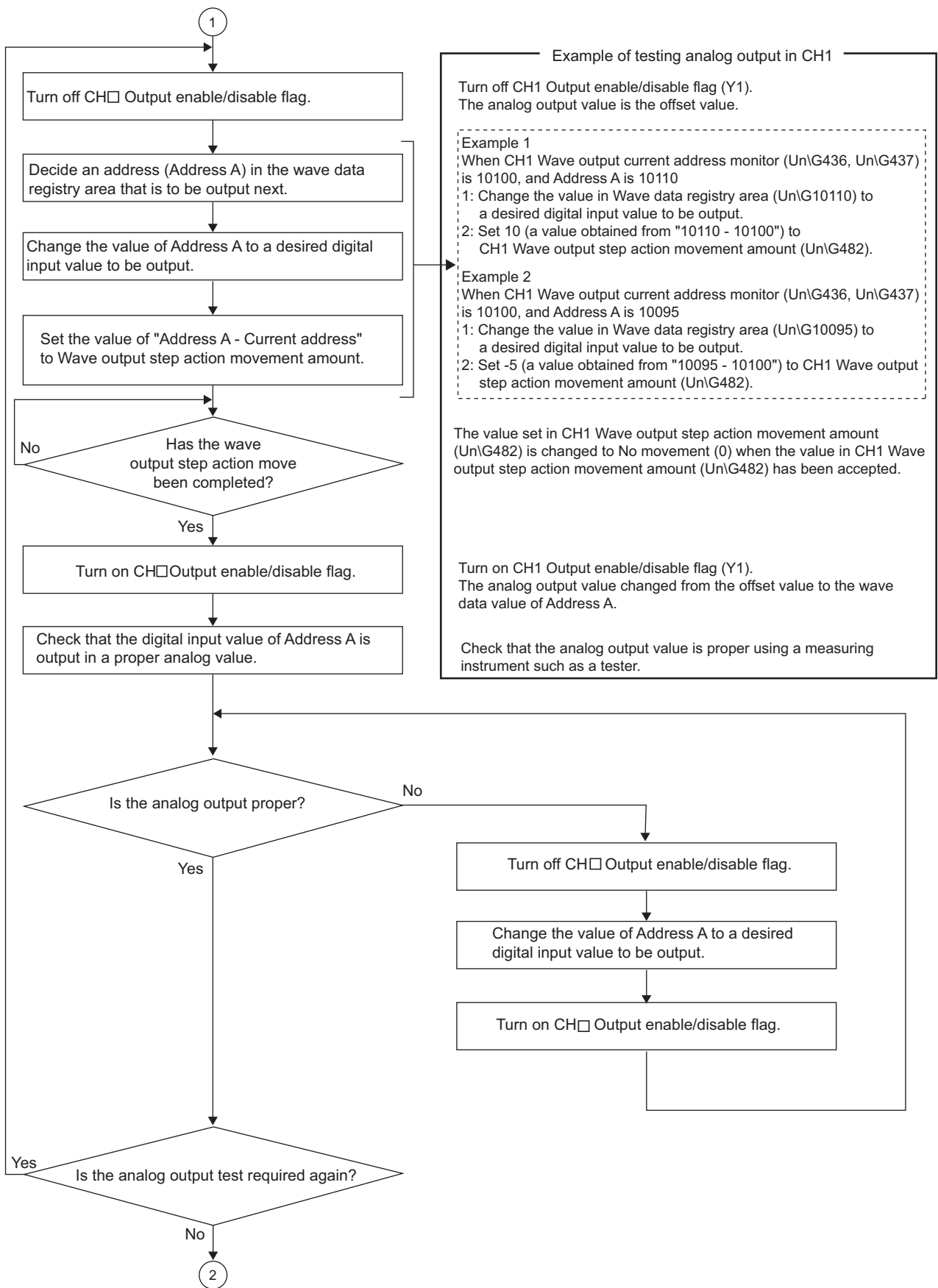

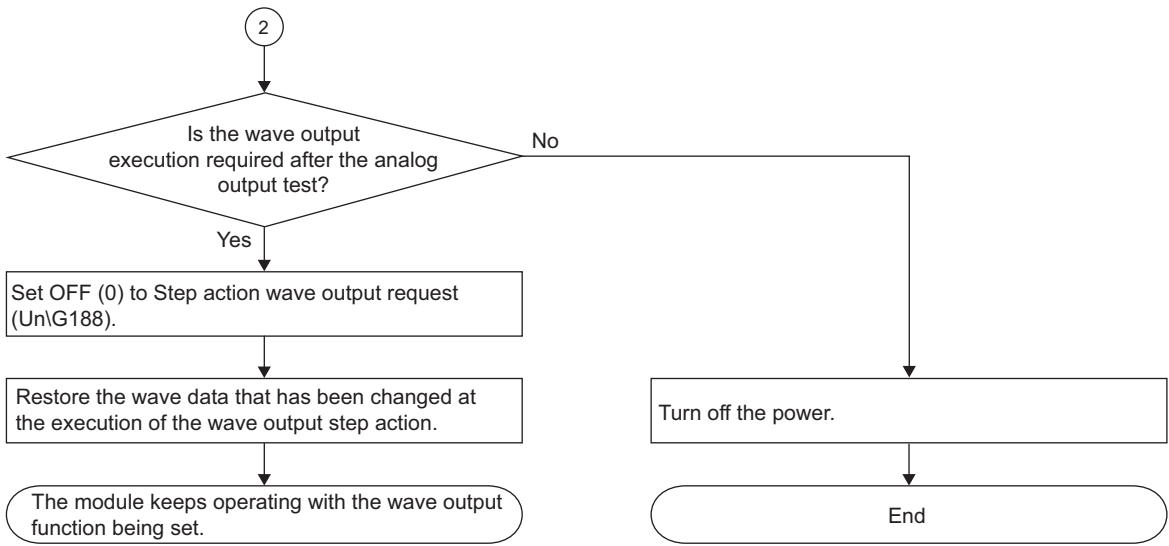

1.15 Inter-Module Synchronization Function

This function allows the D/A conversion values to be output at the same timing from multiple modules in which the inter-module synchronization function is active.

The analog output timing of each module is determined by the inter-module synchronization cycle set with the system parameter.

Setting procedure

■Setting system parameters

For the setting of the system parameters, refer to the following.

📖 MELSEC iQ-R Inter-Module Synchronization Function Reference Manual

■Setting module parameters

- Output setting during synchronous error

Select whether to continue or stop the synchronization of the D/A converter modules when an inter-module synchronization cross-cycles processing error (error code: 2600H) or inter-module synchronization signal error (error code: 2610H) occurs.

- Operation mode setting

Select "Normal mode (D/A conversion process)".

- Output mode setting

Select "Normal output mode".

- Analog output HOLD/CLEAR function setting

The operation differs from the one in the normal mode. For the difference of the operations performed depending on the setting details of the HOLD/CLEAR setting, refer to the following.

📖 Page 21 In the synchronization normal output mode

■Setting a synchronization digital value

When the synchronization normal output mode is used, 'CH1 Synchronization digital value' (Un\G9500) is output in analog. Set 'CH1 Synchronization digital value' (Un\G9500) with an interrupt program.

For the setting of interrupt programs, refer to the following.

📖 MELSEC iQ-R CPU Module User's Manual (Application)

■Setting the inter-module synchronization cycle

Set the inter-module synchronization cycle that establishes the following relation.

(Inter-module synchronization cycle) > (Run time of the inter-module synchronous interrupt program + Sampling cycle)

Ex.

When the D/A conversion is enabled in CH1 to CH3 and disabled in CH4

Sampling cycle = $80\mu\text{s} \times 3\text{CH} = 240\mu\text{s}$

When the above relation is not established and one of the following operations is performed, an inter-module synchronous cycle time setting enable lower limit shorter error (error code: 1EA0H) occurs and the inter-module synchronization function does not operate.

- When the CPU module status is changed from STOP to RUN ("D/A conversion enable/disable setting" set with the module parameter is applied.)
- When 'Operating condition setting request' (Y9) is turned off and on

Operation

■ Inter-module synchronization processing for the D/A converter module

When the D/A converter module is used in the synchronization normal output mode, 'CH1 Synchronization digital value' (Un\G9500) is imported at the timing when the inter-module synchronous interrupt program is executed and the D/A conversion is performed in the next inter-module synchronization cycle. By setting 'CH1 Synchronization digital value' (Un\G9500) to multiple D/A converter modules using the inter-module synchronous interrupt program, the analog output can be performed from the multiple modules at the same timing.

Ex.

The following figure shows the inter-module synchronization processing of two D/A converter modules (module A and module B).

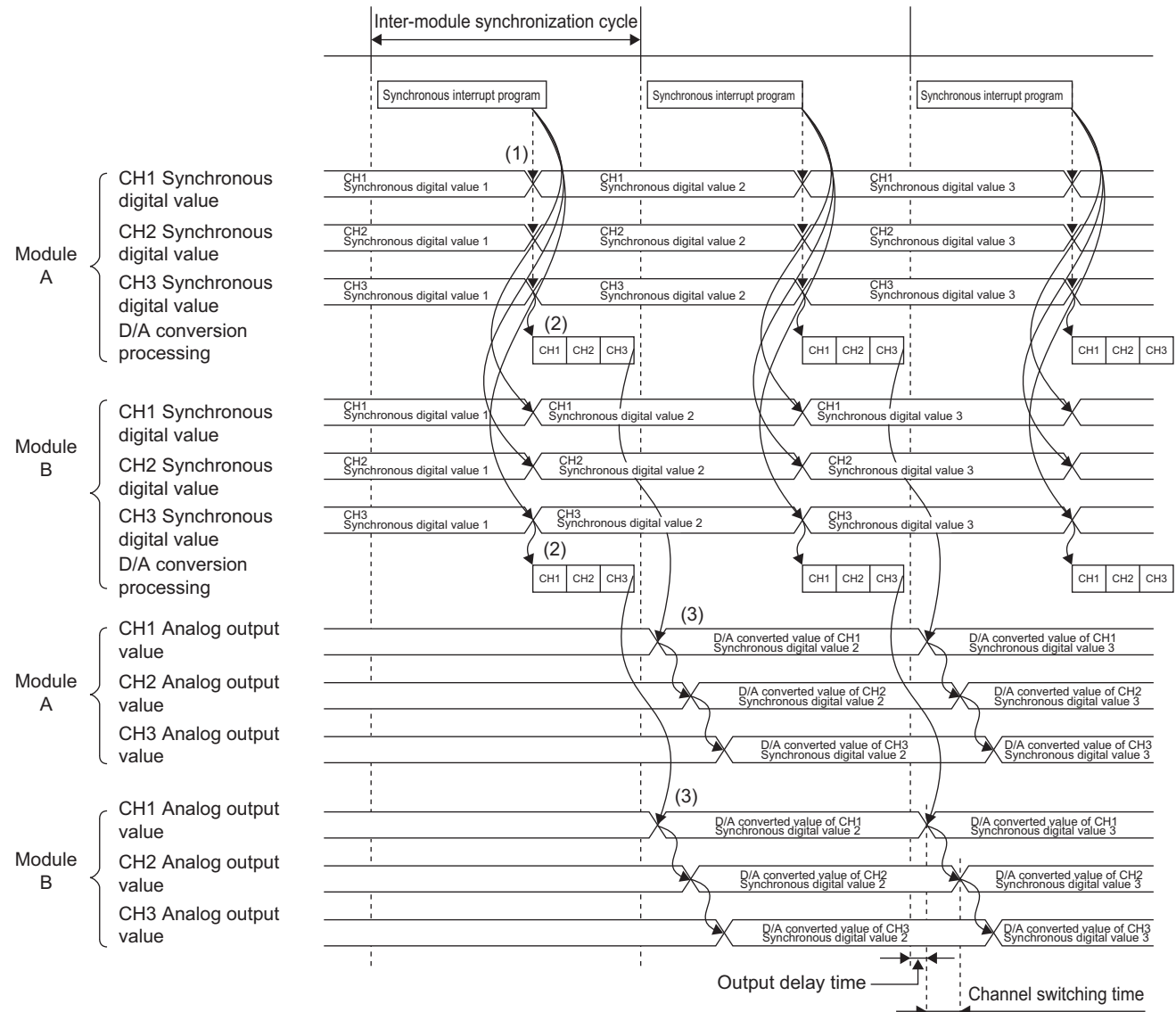

- (1) When the inter-module synchronous interrupt program is executed, the D/A converter module imports CH□ Synchronization digital value.
- (2) The analog output is performed in the inter-module synchronization cycle after (1). The digital value to which the D/A conversion is performed is CH□ Synchronization digital value set in the previous inter-module synchronization cycle.
- (3) The values in CH□ Synchronization digital value are converted in analog in order of CH1, CH2, and CH3 at the start timing of the inter-module synchronization cycle and the converted analog values are output sequentially. The values are output in analog from the channel 1 of the module A and the channel 1 of the module B simultaneously.

- Outputting of the D/A converter module delays for the output delay time from the inter-module synchronization cycle. The output delay time is 24.1 to 25.9 μ s.
- When values are output in analog from multiple channels, the analog output is performed in order of the channel number. Outputting values in analog from each channel delays for the channel switching time after outputting from the previous channel is completed. The channel switching time is 12.3 to 13.2 μ s.

■Abnormal operation during synchronization

- Operation when a cross-cycles processing occurs

The phenomenon in which the D/A conversion is processed crossing over the inter-module synchronization cycles depending on the operation timing of the synchronous interrupt program is called Cross cycles. When the phenomenon occurs, an inter-module synchronization cross-cycles processing error (error code: 2600H) occurs. Whether to continue or stop the operation of the D/A converter module at the occurrence of an error can be selected with "Output selection error during an inter-module synchronization" of the module parameter. With the default value, the module continues the operation.

- Operation when a cycle skipping occurs

The phenomenon in which the D/A conversion is not processed during an inter-module synchronization cycle depending on the operation timing of the synchronous interrupt program is called Cycle skipping. When a cycle skipping occurs, an inter-module synchronization cycle skipping error (error code: 2601H) occurs. When an error occurs, the D/A converter module stops the operation regardless of the setting of "Output selection error during an inter-module synchronization" of the module parameter and the analog output is performed according to the HOLD/CLEAR setting.

- Operation when a synchronization deviation occurs

The phenomenon in which the D/A converter module cannot receive values at the set inter-module synchronization cycle timing or the module receives values at a timing different from the inter-module synchronization cycle timing is called Synchronization deviation. When a synchronization deviation occurs, an inter-module synchronization signal error (error code: 2610H) occurs. Whether to continue or stop the operation of the D/A converter module at the occurrence of an error can be selected with "Output selection error during an inter-module synchronization" of the module parameter. With the default value, the module continues the operation.

■Monitor function

When the inter-module synchronization function is used, the inter-module synchronization status can be monitored.

For details, refer to the following.

 Page 172 Synchronization status monitor

Precautions

- When the inter-module synchronization function is enabled, the rate control function and wave output function cannot be used.
- For the alert output when the inter-module synchronization function is enabled, the update timings of the ALM LED, 'Alert output signal' (XE), 'Alert output upper limit flag' (Un\G36), and 'Alert output lower limit flag' (Un\G37) are changed as follows.

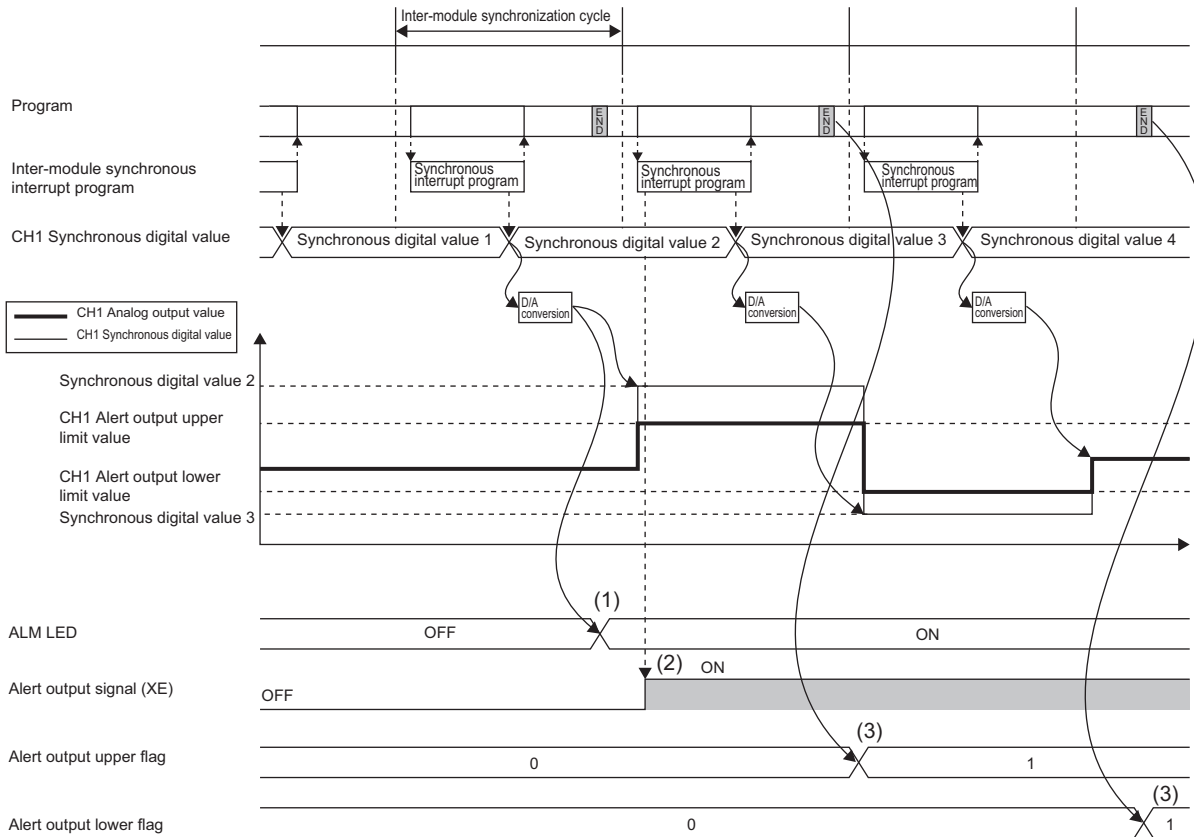

- (1) The ALM LED turns on when the D/A conversion is completed (an alert is detected).
- (2) 'Alert output signal' (XE) is refreshed at the start of the synchronous interrupt program.
- (3) 'Alert output upper limit flag' (Un\G36) and 'Alert output lower limit flag' (Un\G37) are refreshed at the END processing.

- When the external power supply is turned off while the synchronize modules function operates, 0V/0mA is output from all the channels. After the external power supply is turned on and the synchronous interrupt program after 'External power supply READY flag' (X7) turns on is executed, the analog output is restarted.

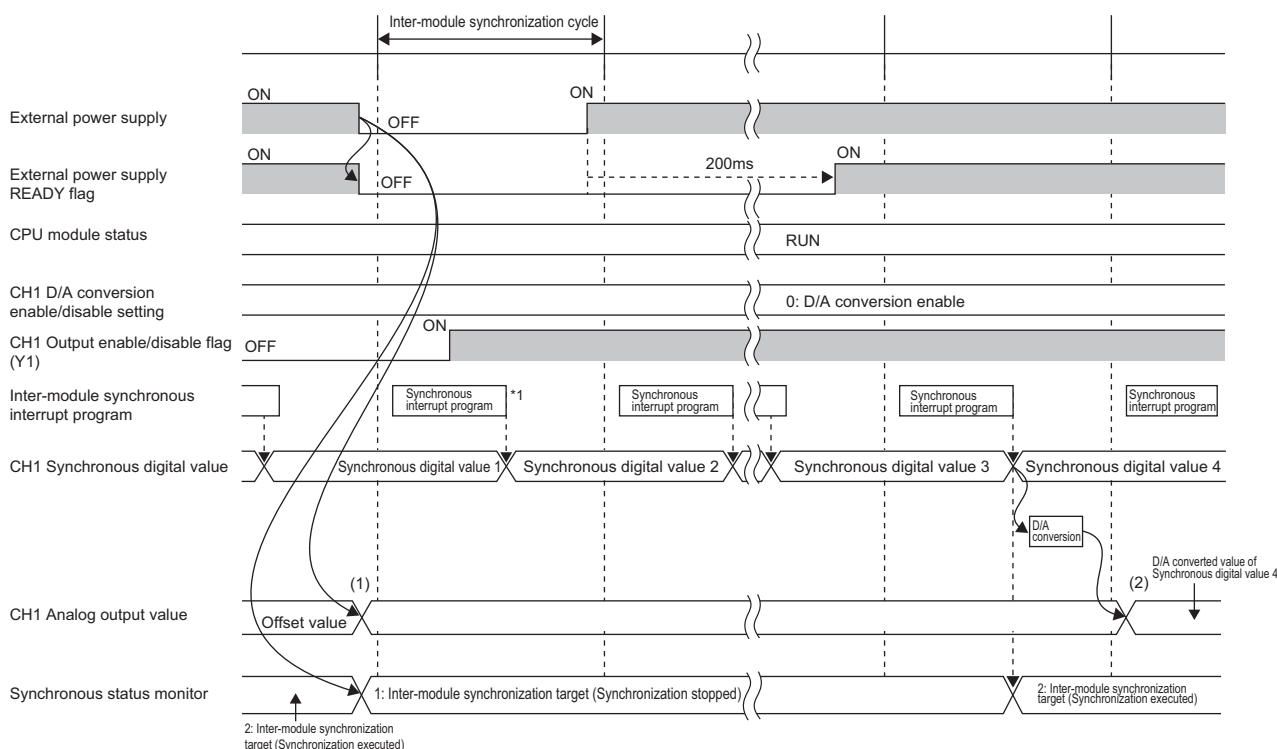

(1) Because the external power supply is turned off, 0V/0mA is output.

(2) 'External power supply READY flag' (X7) turns on and the analog output is restarted after the next synchronous interrupt program is executed.*2

*1 Even when 'External power supply READY flag' (X7) is off, the synchronous interrupt program is executed.

To avoid unnecessary changes of 'CH1 Synchronization digital value' (Un\G9500) during the execution of the synchronous interrupt program, set 'External power supply READY flag' (X7) as the interlock condition in the program.

*2 Note that the analog output is restarted according to the conversion enable/disable setting and output enable/disable setting after the synchronous interrupt program after 'External power supply READY flag' (X7) turns on is executed.

- The inter-module synchronization function does not support the synchronization by each channel.
- When the inter-module synchronization function is enabled, the analog output value does not change even though a value is set to 'CH1 Digital value' (Un\G460). When the inter-module synchronization function is enabled, the value set to 'CH1 Synchronization digital value' (Un\G9500) is the digital value to be converted in analog.
- When the module is set as a synchronization target and the offset/gain setting mode is set in the operation mode setting, an inter-module synchronization selection offset/gain setting error (error code: 1EA1H) occurs and the module does not operate.
- When a mode switching setting value is set for 'Mode switching setting' (Un\G296, Un\G297) and 'Operating condition setting request' (Y9) is turned on, an inter-module synchronization mode switching request error (alarm code: 0D00H) occurs, 'Alert output signal' (XE) turns on, and the ALM LED lights. In this case, the mode is not switched and the synchronization processing continues. To clear 'Alert output signal' (XE) and the generated alarm, turn on and off 'Alert output clear request' (YE).
- When performing the offset/gain setting, set the module as a synchronization non-target, and switch to the normal output mode to shift the offset/gain setting mode.
- Dedicated instructions cannot be used.

The following shows the operation when a dedicated instruction is executed.

When the G(P).OFFGAN instruction is executed, an inter-module synchronization mode switching request error (alarm code: 0D00H) occurs.

The G(P).OGLoad instruction is disabled.

When the G(P).OGSTOR instruction is executed, a G(P).OGSTOR instruction execution error in offset/gain setting mode (error code: 1860H) is stored in the dedicated instruction completion status.

For details on the dedicated instructions, refer to the following.

📖 MELSEC iQ-R Programming Manual (Module Dedicated Instructions)

- When the module is set as a synchronization target and the wave output mode is set in the operation mode setting, an inter-module synchronization selection wave output mode setting error (error code: 1EA4H) occurs and the module does not operate.

1.16 Error History Function

This function stores up to the latest 16 errors and alarms that occurred in the D/A converter module to the buffer memory area.

Operation

When an error occurs, the error code and the error time are stored from 'Error history No.1' (Un\G3600 to Un\G3609) in order. When an alarm occurs, the alarm code and the alarm code time are stored from 'Alarm history No.1' (Un\G3760 to Un\G3769) in order.

- Detail of the error code assignment

	b15	to	b8	b7	to	b0
Un\G3600	Error code					
Un\G3601	First two digits of the year			Last two digits of the year		
Un\G3602	Month			Day		
Un\G3603	Hour			Minute		
Un\G3604	Second			Day of the week		
Un\G3605	Millisecond (Upper)			Millisecond (Lower)		
Un\G3606	System area					
to						
Un\G3609						

- Detail of the alarm code assignment

	b15	to	b8	b7	to	b0
Un\G3760	Alarm code					
Un\G3761	First two digits of the year			Last two digits of the year		
Un\G3762	Month			Day		
Un\G3763	Hour			Minute		
Un\G3764	Second			Day of the week		
Un\G3765	Millisecond (Upper)			Millisecond (Lower)		
Un\G3766	System area					
to						
Un\G3769						

Ex.

Storing example of error history and alarm history

Item	Storage contents	Storage example*1
First two digits of the year/Last two digits of the year	Stored in BCD code.	2014H
Month/Day		630H
Hour/Minute		1234H
Second		56H
Day of the week	One of the following values is stored in BCD code. Sunday: 0, Monday: 1, Tuesday: 2, Wednesday: 3 Thursday: 4, Friday: 5, Saturday: 6	1H
Millisecond (upper)	Stored in BCD code.	7H
Millisecond (lower)		89H

*1 Values stored when an error occurs at 12:34:56.789 on Monday, June 30th, 2014.

The start address of Error history where the latest error is stored can be checked in 'Latest address of error history' (Un\G1).

The start address of Alarm history where the latest alarm is stored can be checked in 'Latest address of alarm history'

(Un\G3).

Ex.

When the third error occurs:

The third error is stored in Error history No.3, and the value 3620 (start address of Error history No.3) is stored to Latest address of error history.

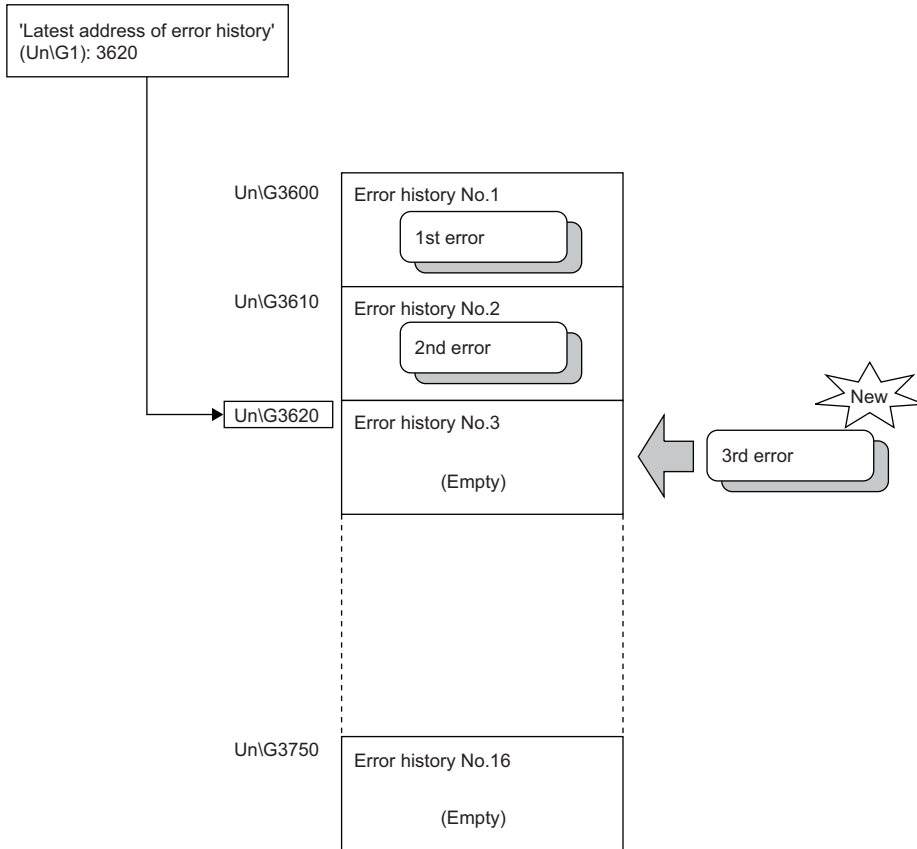

Ex.

When the 17th error occurs:

The 17th error is stored in Error history No.1, and the value 3600 (start address of Error history No.1) is stored to Latest address of error history.

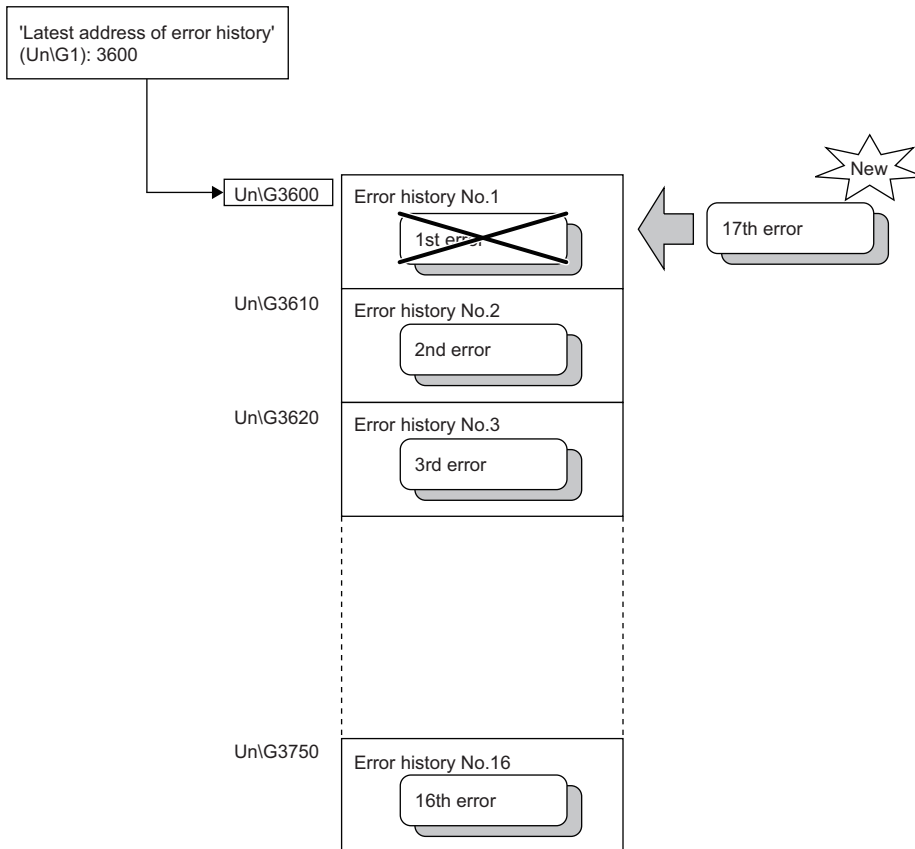
Point

- Once the error history storage area becomes full, subsequent error information will overwrite the existing data, starting from 'Error history No.1' (Un\G3600 to Un\G3609), and continues sequentially thereafter. The overwritten history is deleted.
- The same processing is performed for Alarm history when an alarm occurs.
- The stored error history is cleared when the D/A converter module is powered off, or when the CPU module is reset.

1.17 Event History Function

This function collects generated errors, alarms, or executed operations in the D/A converter module as event information in the CPU module.

The CPU module collects the event information occurred in the D/A converter module and keeps them in the data memory inside of the CPU module or an SD memory card.

The event information collected by the CPU module can be displayed on an engineering tool to check the occurrence history in a time series.

Event type	Classification	Description
System	Error	An error detected by the self diagnostics in each module.
	Warning	A warning (alarm) detected in each module.
	Information	The operation by the normal detection of the system that is not classified as error or warning, or the operation performed automatically by the system.
Security	Warning	Operation that is judged as an unauthorized access to each module.
	Information	Operation that is hard to be judged as the success of unlocking passwords or an unauthorized access.
Operation	Warning	Deleting (data clear) operations that may change the action. (These operations are not judged as errors by the self diagnostics.)
	Information	Operations performed by users to change the system operation or configuration in the offset/gain setting.

Setting procedure

The event history function can be set from the event history setting window of the engineering tool. For the setting procedure, refer to the following.

 MELSEC iQ-R CPU Module User's Manual (Application)

Displaying event history

Use the menu of the engineering tool. For details on the operating procedure and display contents, refer to the following.

 GX Works3 Operating Manual

Event history list

The following table lists the events that occur in the D/A converter module when the event type is Operation.

Event code	Event classification	Event name	Event details	Additional information
20010	Information	Offset/gain setting	The offset/gain in the user range setting has been set.	Cumulative number of writing times
20100	Information	Error clear	The error clear request has been executed.	—

1.18 Backing up, Saving, and Restoring Offset/Gain Values

The D/A converter module is capable of backing up, saving, and restoring offset/gain values of the user range.

- Backup: Creates a module-specific backup parameter and saves offset/gain values.
- Save: Saves the offset/gain information, registered in this module by making the offset/gain setting, in the CPU module.
- Restoration: Writes the information backed up and saved in the CPU module to this module.

In the event that the D/A converter module fails and needs to be replaced, the offset/gain values of the failed D/A converter module can be restored onto the replaced D/A converter module.

In addition, if multiple D/A converter modules are connected on a system, the offset/gain settings in one of the D/A converter modules can be applied to the other modules.

However, if the offset/gain values are saved and restored, the accuracy after the restoration decreases by approximately three times compared to that before the restoration. Reconfigure the offset/gain setting when required.

Only when the model where the offset/gain values are to be saved and the model where the offset/gain values are to be restored are the same, the offset/gain values can be saved and restored.

Each procedure differs depending on whether a module-specific backup parameter is used or not.

When a module-specific backup parameters is used

At the time of replacement by means of online module change, the offset/gain values are automatically restored.

For details on the online module change, refer to the following.

 MELSEC iQ-R Online Module Change Manual

Details of the module-specific backup parameter

A module-specific backup parameter is a file created in an SD memory card or the data memory of the control CPU.

The contents of the parameter are the offset/gain value of the user range stored in the flash memory of the D/A converter module.

The file name of a module-specific backup parameter is determined as follows based on the start I/O number of the D/A converter module.

UBPmmmn.BPR

- mmm indicates a value calculated by dividing the module I/O No. by 10H (3 digits in hexadecimal).
- nn indicates a consecutive number of the module-specific backup parameters for each module and fixed to 00.

Creating and updating a module-specific backup parameter

A module-specific backup parameter is created or updated when the offset/gain values stored in the flash memory of the D/A converter module are updated.

Timing when backup data is created or updated	Description
When the offset/gain setting is completed with "Offset/gain setting" of the engineering tool	A module-specific backup parameter is created or updated when the offset/gain setting is completed with "Offset/gain setting" of the engineering tool.
When 'User range write request' (YA) is turned on in the offset/gain setting mode	A module-specific backup parameter is created or updated when the offset/gain values of the user range are changed in the offset/gain setting mode.
When 'User range write request' (YA) is turned on in the normal mode	When 'User range write request' (YA) is turned on in the normal mode, the offset/gain values of the user range are restored based on the settings of the buffer memory areas (Save data type, CH1 Factory default setting offset value to CH8 User range setting gain value). At this timing, module-specific backup parameters are updated.
When the G(P).OGSTOR instruction is executed in the normal mode	When the G(P).OGSTOR instruction is executed in the normal mode, the offset/gain values of the user range are restored. At this timing, module-specific backup parameters are updated.
When a new module is recognized after the online module change	When a new module is mounted and recognized after the online module change, the offset/gain values of the user range are restored. At this timing, module-specific backup parameters are updated.

When no module-specific backup parameter exists in the data memory of the control CPU and a module-specific backup parameter needs to be created with the current setting, change the mode of the D/A converter module to the offset/gain setting mode and turn on 'User range write request' (YA). A module-specific backup parameter is created with the current setting of the flash memory.

■Precautions

If the creation of a module-specific backup parameter fails because the data memory of the control CPU does not have sufficient free space or the module-specific backup parameter is being used, a module-specific backup parameter creation error (error code: 17E1H) occurs.

Reading of module-specific backup parameters

To read a module-specific backup parameter and restore offset/gain values, set "Auto restore of Offset/gain setting with the module change" of the module parameter to "Enable" in advance.

Navigation window ⇒ [Parameter] ⇒ [Module Information] ⇒ Module model name ⇒ [Module Parameter] ⇒ "Application setting" ⇒ "Online module change"

■Reading timing

Module-specific backup parameters are read when a new module is mounted and recognized after the online module change. If the module is replaced with the programmable controller powered off, module-specific backup parameters are not read.

■Precautions

When the module-specific backup parameter for the target slot does not exist in an SD memory card or the data memory of the control CPU, the subsequent restoration of the offset/gain values is not performed. If the offset/gain values cannot be restored even though the module-specific backup parameter exists, a module-specific backup parameter restore error (error code: 17E0H) occurs.

Restoration of the offset/gain values of the user range

Upon the successful completion of reading module-specific backup parameters, the values are converted (restored) into the offset/gain values of the user range for the new module, and stored in the flash memory. At the same time, the module-specific backup parameter in the data memory of the control CPU is updated with the setting of the new module.

Restrictions on the module-specific backup parameter

The back up and restoration by means of module-specific backup parameters fails in the following cases.

- When the control CPU is not the process CPU
- When replacing the D/A converter module with the programmable controller powered off
- When "Auto restore of Offset/gain setting with the module change" of the module parameter is set to "Disable"

In any of the cases above, back up or restore offset/gain values by the following method.

☞ Page 90 When the module-specific backup parameter is not used

When the module-specific backup parameter is not used

Back up or restore offset/gain values by one of the following methods.

- Saving and restoring by dedicated instructions
- Saving and restoring by reading from and writing to the buffer memory

With the method above, offset/gain values can be restored to a new module, or the offset/gain values set in one module can be applied to the other modules in the same system.

- To restore offset/gain values onto a new replaced module:

1. Save the offset/gain values.

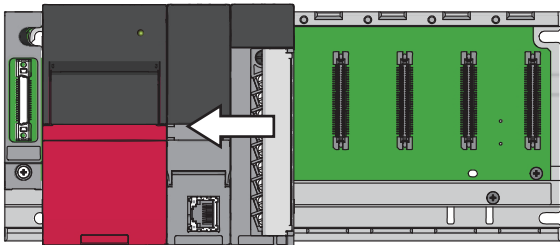

2. Replace the D/A converter module.

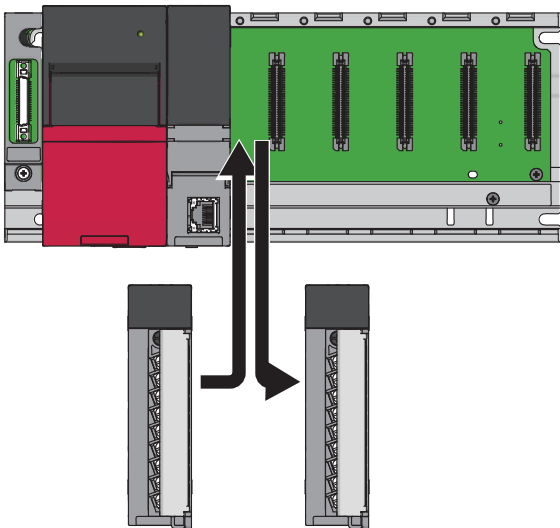

3. Restore the offset/gain values.

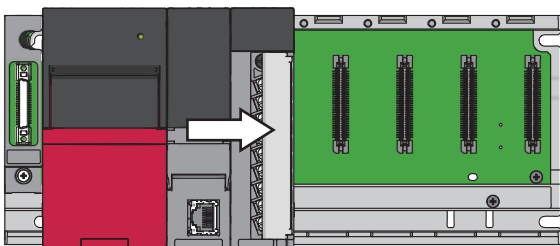

- To apply the offset/gain values set in one module to the other modules in the same system:

Ex.

When the offset/gain values in module No.1 are applied to modules No.2 to No.4

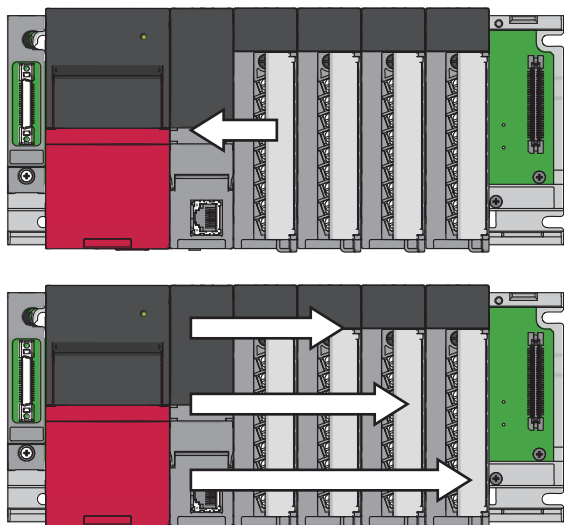

1. Save the offset/gain values of module No.1.

2. Apply the offset/gain values to modules No.2 to No.4.

Methods for saving and restoring offset/gain values

The offset/gain values can be saved and restored by the following two types of operations.

- Saving and restoring by dedicated instructions
- Saving and restoring by reading from and writing to the buffer memory

■ Saving and restoring by dedicated instructions

Use the dedicated instruction G(P).OGLOAD to temporarily save the offset/gain values of the source D/A converter module to the internal device of the CPU, then use G(P).OGSTOR to write the values to the destination D/A converter module.

Prevent the saved offset/gain setting data from being deleted, by one of the following methods before replacing the modules:

- Use latch settings for the internal device of the destination module.
- Save the data onto an SD memory card. (To write data: use the SP.FWRITE instruction. To read data: use the SP.FREAD instruction.)
- Store the saved data.

For use of dedicated instructions, refer to the following.

📖 MELSEC iQ-R Programming Manual (Module Dedicated Instructions)

■ Saving and restoring by reading from and writing to the buffer memory

Use Save data type setting, CH1 Factory default setting offset value to CH8 User range setting gain value, and 'User range write request' (YA) to read the offset/gain values from the source D/A converter module. Use the buffer memory again to write the values to the destination D/A converter module.

The following describes the procedure for using the buffer memory.

- To restore offset/gain values onto a new replaced module:

When offset/gain values are restored onto the source D/A converter module	① Set Save data type setting.
	② Turn on and off 'Operating condition setting request' (Y9).
	③ Save the stored values of Save data type setting and CH1 Factory default setting offset value to CH8 User range setting gain value.
When the power of the module is off	④ Replace the D/A converter module.
When offset/gain values are restored onto the destination D/A converter module	⑤ Write the data saved in Save data type setting and CH1 Factory default setting offset value to CH8 User range setting gain value.
	⑥ Turn on 'User range write request' (YA).
	⑦ Check that 'Offset/gain setting mode status flag' (XA) is on.
	⑧ Turn on and off 'User range write request' (YA).
	⑨ Check whether the destination D/A converter module operates with the offset/gain values that are restored.

Point

When replacing modules, prevent the saved offset/gain setting data from being deleted, by one of the following methods before powering off the module.

- Use latch settings for the internal device of the destination module.
- Save the data onto an SD memory card. (To write data: use the SP.FWRITE instruction. To read data: use the SP.FREAD instruction.)
- Store the saved data.

- To apply the offset/gain values set in one module to the other modules in the same system:

When offset/gain values are restored onto the source D/A converter module	① Set Save data type setting.
	② Turn on and off 'Operating condition setting request' (Y9).
	③ Save the stored values of Save data type setting and CH1 Factory default setting offset value to CH8 User range setting gain value.
When offset/gain values are restored onto the destination D/A converter module	④ Write the data saved in Save data type setting and CH1 Factory default setting offset value to CH8 User range setting gain value.
	⑤ Turn on 'User range write request' (YA).
	⑥ Check that 'Offset/gain setting mode status flag' (XA) is on.
	⑦ Turn on and off 'User range write request' (YA).
	⑧ Check whether the destination D/A converter module operates with the offset/gain values that are restored.

Range reference table

The following describes the range reference tables used for saving and restoring offset/gain values.

■ Factory default setting

The following describes the buffer memory addresses of the factory default setting.

R60DA4: 'CH1 Factory default setting offset value' (Un\G4004) to 'CH4 Factory default setting gain value' (Un\G4011)

R60DAV8, R60DAI8: 'CH1 Factory default setting offset value' (Un\G4004) to 'CH8 Factory default setting gain value' (Un\G4019)

- For the R60DA4

Address (decimal)				Description	Save data type setting ^{*1}	Analog value	Reference value (hexadecimal)
CH1	CH2	CH3	CH4				
4004	4006	4008	4010	Industrial shipment settings offset value	Voltage	0V	Approx. 8000H
					Current	0mA	Approx. 0B21H
4005	4007	4009	4011	Industrial shipment settings gain value	Voltage	10V	Approx. FCFFH
					Current	20mA	Approx. E9BCH

*1 The reference values differ depending on the setting of 'Save data type setting' (Un\G4002) (voltage or current).

- For the R60DAV8

Address (decimal)								Description	Analog value	Reference value (hexadecimal)
CH1	CH2	CH3	CH4	CH5	CH6	CH7	CH8			
4004	4006	4008	4010	4012	4014	4016	4018	Industrial shipment settings offset value	0V	Approx. 8000H
4005	4007	4009	4011	4013	4015	4017	4019	Industrial shipment settings gain value	10V	Approx. FCFFH

- For the R60DAI8

Address (decimal)								Description	Analog value	Reference value (hexadecimal)
CH1	CH2	CH3	CH4	CH5	CH6	CH7	CH8			
4004	4006	4008	4010	4012	4014	4016	4018	Industrial shipment settings offset value	0mA	Approx. 0B21H
4005	4007	4009	4011	4013	4015	4017	4019	Industrial shipment settings gain value	20mA	Approx. E9BCH

■ User range setting

The following describes the buffer memory addresses of the user range setting.

R60DA4: 'CH1 User range setting offset value' (Un\G4012) to 'CH4 User range setting gain value' (Un\G4019)

R60DAV8, R60DAI8: 'CH1 User range setting offset value' (Un\G4020) to 'CH8 User range setting gain value' (Un\G4035)

Offset/gain value		Reference value (hexadecimal)
Voltage	0V ^{*1}	Approx. 8000H
	1V	Approx. 8C80H
	5V	Approx. BE80H
	10V ^{*2}	Approx. FCFFH
Current	0mA	Approx. 0B21H
	4mA ^{*3}	Approx. 37A7H
	20mA ^{*4}	Approx. E9BCH

*1 This value is stored in User range setting offset value by default of the R60DAV8.

*2 This value is stored in User range setting gain value by default of the R60DAV8.

*3 This value is stored in User range setting offset value by default of the R60DA4 and R60DAI8.

*4 This value is stored in User range setting gain value by default of the R60DA4 and R60DAI8.

1.19 Q Compatible Mode Function

This function controls an operation state with the buffer memory layout of the D/A converter module converted to equivalent of the addresses of the compatible modules of the MELSEC-Q series.

This compatibility makes it possible to reuse sequence programs that have exhibited high performance on the MELSEC-Q series analog output modules.

The following table lists the compatible modules of the MELSEC-Q series.

MELSEC iQ-R series analog output module	Compatible analog output module
R60DA4	Q64DAN
R60DAV8	Q68DAVN
R60DAI8	Q68DAIN

Operation

Only the buffer memory assignment is changed in the Q compatible mode.

- The I/O signal assignment is the same as the one for the R mode. 'High resolution mode status flag' (X8) of the MELSEC-Q series is deleted and 'Synchronous output mode flag' (XD) is changed to 'Disconnection detection signal' (XD) and 'Synchronous output request' (YD) is changed to 'Disconnection detection clear request' (YD). However, the signals that change the module operation maintain the compatibility. Therefore, when the MELSEC-Q series program is diverted, a significant modification is not required.

Point

- When the MELSEC-Q series program is diverted, check digital values and the operation timing and modify the program if necessary because the specifications such as the resolution and update timing are changed.
- When the MELSEC-Q series program is diverted and an error code is set as the operating condition or interlock condition, the program does not operate normally.
- When the Q compatible mode function is enabled, a program that uses FB or labels cannot be created. When FBs or labels are used, create a program in the R mode.

Setting procedure

1. When adding a new module, select the module whose module name has "(Q)" at the end.

 avigation window ⇒ [Parameter] ⇒ [Module Information] ⇒ Right-click ⇒ [Add New Module...]

2. Configure the same parameter setting as the one of when the R mode is used.
3. Restart the CPU module after the module parameter is written.

Point

- During the module operation, the mode cannot be switched between the R mode and Q compatible mode.
- The project of the compatible D/A converter module created by GX Works2 can be read with the other format read function of GX Works3. The read project keeps various settings of the compatible D/A converter module as the settings of the D/A converter module of the MELSEC iQ-R series. The settings to be kept are the switch setting, parameter setting, auto refresh setting, and I/O assignment.

2 PARAMETER SETTING

Set the parameters of each channel.

Setting the parameters eliminates the need for programming them.

2

2.1 Basic Setting

Setting procedure

Open "Basic settig" of the engineering tool.

1. Start Module parameter.

Navigation window ⇒ [Parameter] ⇒ [Module Information] ⇒ Module name ⇒ [Module parameter] ⇒ [Basic settig]

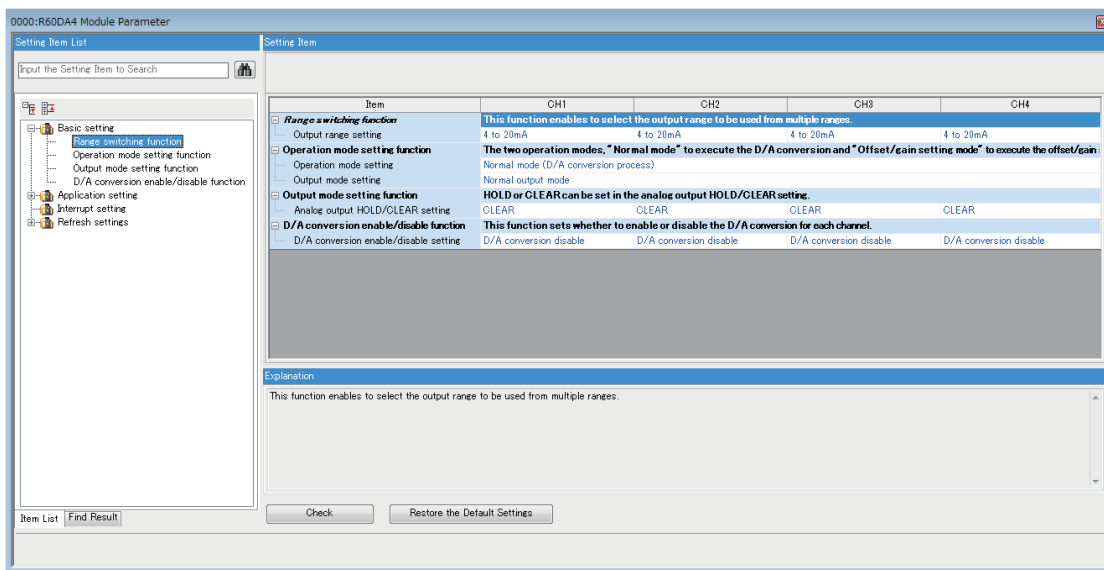

2. Double-click the item to be changed to enter the setting value.

- Item where a value is selected from the pull-down list

Click the [▼] button of the item to be set, and from the pull-down list that appears, select the value.

- Item where a value is entered into the text box

Double-click the item to be set to enter the numeric value.

2.2 Application Setting

Setting procedure

Open "Application setting" of the engineering tool.

1. Start Module parameter.

Navigation window ⇒ [Parameter] ⇒ [Module Information] ⇒ Module name ⇒ [Module parameter] ⇒ [Application setting]

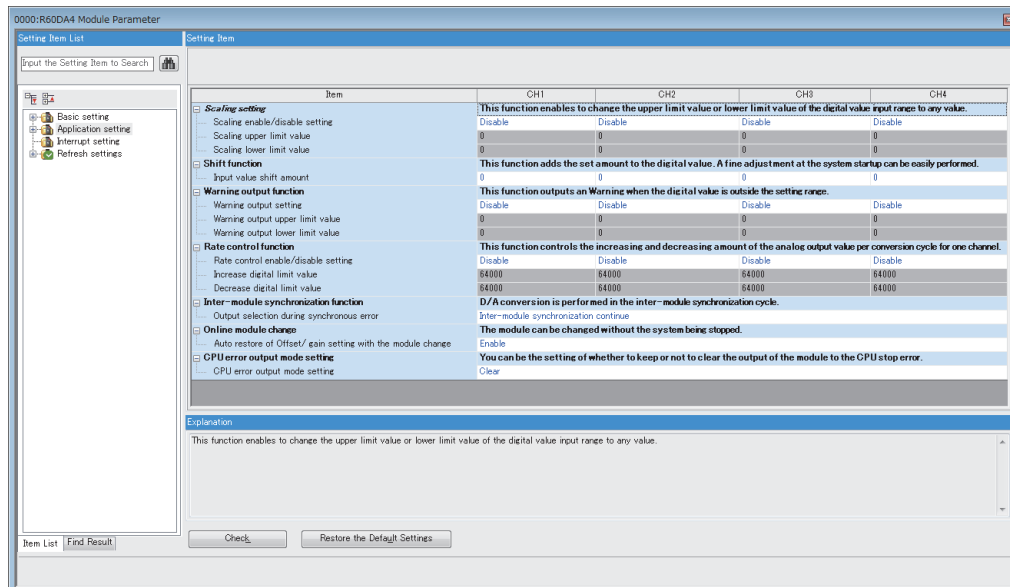

2. Double-click the item to be changed to enter the setting value.

- Item where a value is selected from the pull-down list

Click the [▼] button of the item to be set, and from the pull-down list that appears, select the value.

- Item where a value is entered into the text box

Double-click the item to be set to enter the numeric value.

2.3 Interrupt Setting

Setting procedure

Open "Interrupt setting" of the engineering tool.

1. Start Module parameter.

Navigation window ⇒ [Parameter] ⇒ [Module Information] ⇒ Module name ⇒ [Module parameter] ⇒ [Interrupt setting]

2

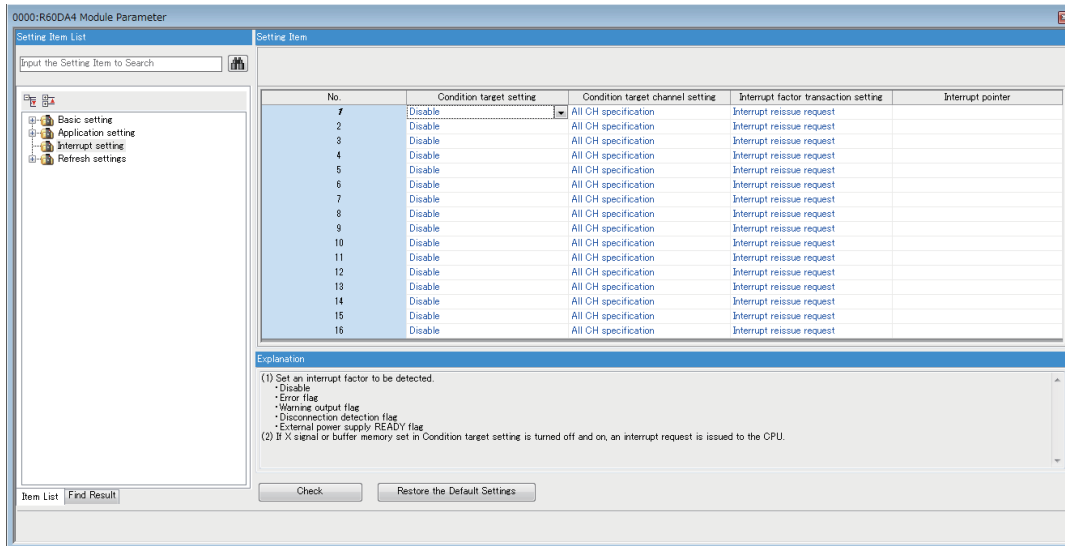

2. Click the interrupt setting number (No.1 to 16) to be changed to enter the setting value.

- Item where a value is selected from the pull-down list

Click the [▼] button of the item to be set, and from the pull-down list that appears, select the value.

- Item where a value is entered into the text box

Double-click the item to be set to enter the numeric value.

2.4 Refresh Settings

Setting procedure

Set the buffer memory area of the D/A converter module to be refreshed automatically.

This refresh setting eliminates the need for reading/writing data by programming.

1. Start Module parameter.

Navigation window ⇒ [Parameter] ⇒ [Module Information] ⇒ Module name ⇒ [Module parameter] ⇒ [Refresh settings]

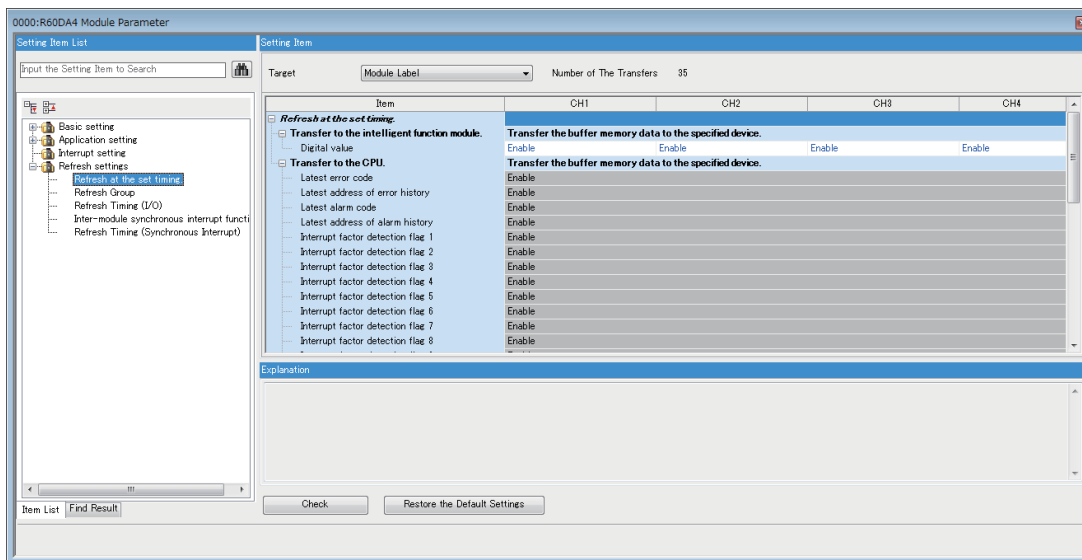

2. Click "Target" and set the refresh destination.

- When "Target" is "Module Label"

Set whether to enable or disable the auto refresh by setting "Digital value" to Enable or Disable.

- When "Target" is "Refresh Data Register (RD)"

The transfer destinations of all items are automatically set by setting the start device to "Top Device Name".

- When "Target" is "Device"

Double-click the item to be set to enter the numeric value.

3. Click "Refresh Timing" to set the timing to execute the auto refresh.

Set "Refresh Timing" to "At the Execution Time of END Instruction" or "At the Execution Time of Specified Program".

When "At the Execution Time of Specified Program" is set, double-click "Refresh Group [n] (n: 1-64)" and set a value of 1 to 64.

Point

- When the inter-module synchronization function is used and the refresh target is set to "Specified Device", the auto refresh destination device must be written into "Inter-module synchronous interrupt function".
- With refresh enabled, the value of the refresh destination takes effect at the timing of refresh which is set up by the engineering tool. As this happens, the buffer memory is overwritten with the value of the refresh destination. To change the value of a buffer memory area to be refreshed, change the value of module label or device at the refresh destination in the program.

Refresh processing time

Refresh processing time [μs] is included in the scan time of the CPU module. For the scan time, refer to the following.

 MELSEC iQ-R CPU Module User's Manual (Application)

The refresh processing time [μs] required for the refresh settings is calculated by the following formula.

- Refresh processing time [μs] = Time for reading refresh (for transfer to the CPU module) + Time for writing refresh (for transfer to the intelligent function module)

The time for reading refresh and writing refresh differ depending on the setting in "Target".

When the inter-module synchronization function is used, the time for reading refresh and writing refresh is added at the execution of the inter-module synchronous interrupt program.

When "Target" is Module Label or Refresh Data Register (RD)

The following table lists the time for reading refresh and writing refresh when the R□CPU is used.

Model name	Classification	When refresh settings are configured	When the inter-module synchronization function is used
R60DA4	Reading refresh	18.85 μs	12.63 μs
	Writing refresh	11.5 μs	9.76 μs
R60DAV8, R60DAI8	Reading refresh	23.17 μs	12.63 μs
	Writing refresh	13.9 μs	9.84 μs
R60DA4 (Q compatible mode)	Reading refresh	19.18 μs	12.63 μs
	Writing refresh	9.72 μs	9.76 μs
R60DAV8, R60DAI8 (Q compatible mode)	Reading refresh	19.38 μs	12.63 μs
	Writing refresh	9.76 μs	9.84 μs

When "Target" is Device

Calculate the time for reading refresh and writing refresh depending on the number of items set in the refresh settings and the number of items to be transferred (words). For the calculation method, refer to the following.

 MELSEC iQ-R CPU Module User's Manual (Application)

3 TROUBLESHOOTING

This chapter describes errors that may occur while using the D/A converter module, and those troubleshooting.

3.1 Checking Using LEDs

Checking the display status of LEDs enables the primary diagnosis without an engineering tool and can narrow the range of trouble causes.

The D/A converter module status can be checked using the RUN LED, ERR LED, and ALM LED. The following table lists the correspondence relation between each LED and the D/A converter module status.

Name	Description
RUN LED	Indicates the operating status of the module. On: Normal operation Flashing (1s cycles): In offset/gain setting mode Flashing (400ms cycles): Selected as a module for the online module change Off: 5V power supply interrupted, watchdog timer error occurred, or module replacement allowed in the process of the online module change
ERR LED	Indicates the error status of the module.*1 On: Error occurred Off: Normal operation
ALM LED	Indicates the alarm status of the module.*2 On: Alert output Off: Normal operation

*1 For details, refer to the following.

☞ Page 106 Error Code List

*2 For details, refer to the following.

☞ Page 110 Alarm Code List

3.2 Checking the Status of the Module

Error codes (alarm codes) and the error history of the D/A converter module can be checked in the module diagnostics window of an engineering tool.

[Diagnostics] ⇒ [System Monitor] ⇒ Right-click a module to be checked ⇒ "Module Diagnostics"

The screenshot shows the 'Module Diagnostics' window for module R60DA4. The window title is 'Module Diagnostics(Start I/O No. 0000)'. It features a 'Module Name' field with 'R60DA4' and a 'Production information' field. A 'Supplementary Function' dropdown is set to 'Monitoring', with 'Execute', 'Stop Monitoring', and 'Monitoring' buttons. Below this is a 'Module Information List' tab with a table of error information.

No.	Occurrence Date	Status	Error Code	Overview
1	2014/07/09 22:28:53.141	Minor	1C40	CH1 Disconnection detection error

Buttons for 'Error Jump', 'Event History', 'Clear Error', and 'Detail' are located to the right of the table. A legend below the table identifies error levels: Major (red triangle), Moderate (orange triangle), and Minor (yellow triangle). A 'Detailed Information' section provides the following details:

Detailed Information	-	-	-
Cause	A disconnection is detected in CH1.		
Corrective Action	Eliminate the cause of the disconnection of the corresponding channel, and turn on and off Error clear request (YF).		

At the bottom of the window are 'Create File...' and 'Close' buttons.

3.3 Troubleshooting by Symptom

When the RUN LED flashes or turns off

When flashing

Check item	Cause	Action
Is the module in offset/gain setting mode?	In the module parameter setting of the engineering tool, the programmable controller power supply has been turned off and on, or the CPU has been reset when the operation mode is offset/gain setting mode.	Set the operation mode to the normal mode (D/A conversion process) in the module parameter setting of the engineering tool, and turn off and on the programmable controller power supply or reset the CPU.
	The G(P).OFFGAN instruction has been executed with the mode switched to offset/gain setting mode.	Review the program using the G(P).OFFGAN instruction and check whether the mode switching is wrongly executed.
	The value in the mode switching setting has been changed and the mode has been switched to offset/gain setting mode.	Review the program using Mode switching setting and check whether the mode switching is wrongly executed.

When turning off

Check item	Action
Is the power supplied?	Check that the supply voltage of power supply module is within the rated range.
Is the capacity of power supply module enough?	Check that the power capacity is enough by calculating the current consumption of connected modules, such as the CPU module, I/O modules, and intelligent function modules.
Is the module connected properly?	Check the module connection.
The case other than the above	Reset the CPU module, and check that the RUN LED turns on. If the RUN LED remains off, the module may be failed. Please consult your local Mitsubishi representative.

When the ERR LED turns on

When turning on

Check item	Corrective action
Has any error occurred?	Check Latest error code, and take actions described in the error code list.

When the ALM LED turns on

When turning on

Check item	Corrective action
Has any alert output occurred?	Check the alert output upper limit flag or alert output lower limit flag. For the corrective action, take actions described in the alarm code list. (Page 110 Alarm Code List)

When an analog value is not output

Check item	Corrective action
Is the external power supply 24VDC supplied?	Check 'External power supply READY flag' (X7), and if the flag is off, supply 24VDC to the external power supply terminals (R60DA4: pin number 16, 17, R60DAV8/R60DAI8: pin number 17, 18).
Is there any problem with wiring, such as off or disconnection of analog signal lines?	Check the faulty area by checking the signal line visually or conductively.
Is the CPU module in the STOP status?	Change the status of the CPU module to RUN.
Is the offset/gain setting in the user range setting correct?	When the output range setting is set to the user range setting (current) or user range setting (voltage), turn on and off 'Operating condition setting request' (Y9), and compare the values of CH□ User range setting offset value and CH□ User range setting gain value with the values in the range reference tables. (Page 93 Range reference table) If the stored values are not desired offset/gain values, perform the offset/gain setting again.
Is the output range setting correct?	Check CH□ Range setting monitor in the monitor of the engineering tool. If the output range setting is incorrect, correct the output range setting of the engineering tool or setting of CH□ Range setting.
Is D/A conversion disabled set to D/A conversion enable/disable setting of the channel to output a value?	Check CH□ D/A conversion enable/disable in the monitor of the engineering tool, and set D/A conversion enable/disable setting to D/A conversion enabled with the sequence program or the engineering tool.
Is 'CH□ Output enable/disable flag' (Y1 to Y8) of the channel to output a value off?	Check the on/off state of 'CH□ Output enable/disable flag' (Y1 to Y8). If 'CH□ Output enable/disable flag' (Y1 to Y8) is off, correct the sequence program. In addition, check that the CPU module is not in the STOP status.
Is the program to write a digital value correct?	Check CH□ Digital value using the monitor of the engineering tool (buffer memory batch monitor or intelligent function module monitor). If the value set to Digital input value is not stored, correct the write program.
Has 'Operating condition setting request' (Y9) been executed?	Turn on and off 'Operating condition setting request' (Y9) and check that the analog output is performed properly. When the output is performed properly, review the sequence program.

When an analog value is not output with the wave output function being selected

Check for the module according to the following procedure.

Check item		Corrective action
Check the module parameter setting of the engineering tool.	Is the drive mode setting correct?	Check that 'Offset/gain setting mode flag' (XA) is off, and the operation mode setting is normal mode. If the normal mode (D/A conversion process) is not set, set the operation mode setting to the normal mode (D/A conversion process) in the module parameter setting of the engineering tool.
	Is the output mode setting correct?	Check that the output mode is set to the wave output mode. If the wave output mode is not set, set the output mode setting to the wave output mode in the module parameter setting of the engineering tool.
	Is the user range setting selected?	If the output mode setting is set to the wave output mode, the output range cannot be set to the user range setting (current) or user range setting (voltage). If the user range setting (current) or user range setting (voltage) is set to the output range, set a value other than the user range setting.
Check the program.	Is D/A conversion disabled set to CH□ D/A conversion enable/disable setting of the channel to output a wave signal?	Check CH□ D/A conversion enable/disable setting and set D/A conversion enable.
	Has 'Operating condition setting request' (Y9) been executed?	Turn on and off 'Operating condition setting request' (Y9) to enable the parameter setting of the wave output function.
	Is any value written to the wave data registry area which is used for the channel to output a wave signal?	Check the value in the wave data registry area which is used for the channel to output a wave signal. During a pause of the wave output, the monitors of the wave output function can be checked. After setting HOLD for the analog output HOLD/CLEAR function, set Wave output pause request (2) for CH□ Wave output start/stop request to pause the analog output. Then, check the monitors.
	Is Wave output stop request (0) set to CH□ Wave output start/stop request of the channel to output a wave signal?	Check CH□ Wave output status monitor of the channel to output a wave signal. If Wave output stop (0) is set to CH□ Wave output status monitor, set Wave output start request (1) to CH□ Wave output start/stop request.
	Is 'CH□ Output enable/disable flag' (Y1 to Y8) of the channel to output a wave signal off?	Check the status of 'CH□ Output enable/disable flag' (Y1 to Y8). If 'CH□ Output enable/disable flag' (Y1 to Y8) is off, correct the program.
Check the connection method.	Is the external power supply 24VDC supplied?	Check 'External power supply READY flag' (X7), and if the flag is off, supply 24VDC to the external power supply terminals (R60DA4: pin number 16, 17, R60DAV8/R60DAI8: pin number 17, 18).

When HOLD of analog output value is not available

Check item	Action
Is the analog output HOLD/CLEAR function setting correct?	Check CH□ HOLD/CLEAR function setting monitor. If the setting is incorrect, set the analog HOLD/CLEAR setting to HOLD in the module parameter setting of the engineering tool, and turn off and on the programmable controller or reset the CPU module.

When the synchronization output is not performed



Check for the module according to the following procedure.

Check item		Action
Check the system parameter setting of GX Works3.	Is the module used set as a target module to be synchronized?	Check the synchronization status monitor. If the monitor status is inter-module synchronization non-target (0), the module used is not set as a target module to be synchronized. Set the module as a target module to be synchronized in the system parameter setting of GX Works3.
Check the module parameter setting of GX Works3.	Is the drive mode setting correct?	Check that 'Offset/gain setting mode flag' (XA) is off, and the operation mode setting is normal mode. If the normal mode (D/A conversion process) is not set, set the operation mode setting to the normal mode (D/A conversion process) in the module parameter setting of GX Works3.
Check the operating status of the CPU module.	Is the operation switch set to STOP or is the CPU module in the stop error state?	Set the operation switch to RUN. In addition, when the stop error occurred, refer to the following to eliminate the cause.  Page 106 Error Code List
Check the program.	Is D/A conversion disabled set to CH□ D/A conversion enable/disable setting of the channel to output a value?	Check CH□ D/A conversion enable/disable setting and set D/A conversion enable.
	Has 'Operating condition setting request' (Y9) been executed?	Turn on and off 'Operating condition setting request' (Y9) to enable the parameter setting of the output function.
	Is 'CH□ Output enable/disable flag' (Y1 to Y8) of the channel to output a value off?	Check the status of 'CH□ Output enable/disable flag' (Y1 to Y8). If 'CH□ Output enable/disable flag' (Y1 to Y8) is off, correct the program.
	Is the inter-module synchronous interrupt program (I44) prepared?	When the synchronization output is performed, the value of CH□ Synchronization digital value must be written in the inter-module synchronous interrupt program.
	Has the EI instruction been executed?	To execute the inter-module synchronous interrupt program, the EI instruction must be executed in the program. Execute the EI instruction.
	Is a value written to CH□ Digital value?	For the synchronization output, a value must be written to CH□ Synchronization digital value. When CH□ Digital value is used, correct the program to write a value to CH□ Synchronization digital value.
Check the connection method.	Is the external power supply 24VDC supplied?	Check 'External power supply READY flag' (X7), and if the flag is off, supply 24VDC to the external power supply terminals (R60DA4: pin number 16, 17, R60DAV8/R60DAI8: pin number 17, 18).

3

When 'External power supply READY flag' (X7) does not turn on

Check the module according to the following procedure.

Check item	Action
Is the external power supply 24VDC supplied? (1) Is the external power supply correctly wired? (2) Is the external power supply 24VDC supplied within the specified range?	(1) Wire the external power supply by referring to the "External Wiring". ( MELSEC iQ-R Digital-Analog Converter Module User's Manual (Startup)) (2) Supply 24VDC within the range of the performance specifications. ( MELSEC iQ-R Digital-Analog Converter Module User's Manual (Startup))
The case other than the above	The possible cause is a failure of the D/A converter module. Please consult your local Mitsubishi representative.

Point

If the D/A converter module does not operate properly even after the above actions are taken, the module may be failed. Please consult your local Mitsubishi representative.

3.4 Error Code List

When an error occurs during operation, the D/A converter module stores an error code in 'Latest error code' (Un\G0) of the buffer memory. In addition, 'Error flag' (XF) turns on. Turning on 'Error clear request' (YF) clears the error code in 'Latest error code' (Un\G0), and 'Error flag' (XF) turns off.

Error codes of the D/A converter module are classified in minor errors or moderate errors.

- Minor error: This error is caused by the setting failure of programs and parameters. The D/A conversion continues with the parameter setting before the change. (1000H to 1FFFH)
- Moderate error: Hardware failures and errors at the execution of the inter-module synchronization function are included. The D/A conversion do not continue. (2000H to 2FFFH, 3000H to 3FFFH)

The following table shows the error codes stored.

□ in error codes: Indicates the channel number of a generated error. A numerical value of 0 to 7 is used to correspond to channel 1 to 8.

(CH1: 0, CH2: 1, CH3: 2, CH4: 3, CH5: 4, CH6: 5, CH6: 5, CH7: 6, CH8: 7)

△ in error codes: Indicates the interrupt setting corresponding to an error (0: Setting 1 to F: Setting 16).

Error code	Error name	Description and cause	Action
0000H	—	There is no error.	—
1080H	Number of writes to offset/gain settings reach limit error	The number of the offset/gain settings has exceeded the guaranteed maximum number.	Any further setting of offset/gain values may not be reflected correctly.
17E0H	Module-specific backup parameter restore error	Offset/gain values cannot be restored with the module-specific backup parameter.	The module-specific backup parameter file may be damaged. Readjust the user range.
17E1H	Module-specific backup parameter creation error	The module-specific backup parameter has not been created.	Check the free space on the data memory of the control CPU and the SD memory card, and recreate a module-specific backup parameter. For how to create module-specific backup parameters, refer to the following. ☞ Page 88 Backing up, Saving, and Restoring Offset/Gain Values
180△H	Interrupt factor generation setting range error	A value other than 0 to 1 is set in Interrupt factor generation setting [n].	Set Interrupt factor generation setting [n] to 0 or 1.
181△H	Condition target setting range error	A value other than 0 to 4 is set in Condition target setting [n].	Set Condition target setting [n] to 0 to 4.
182△H	Condition target channel setting range error	A value other than 0 to 8 (for R60DA4, 0 to 4) is set in Condition target channel setting [n].	Set Condition target channel setting [n] to 0 to 8 (for R60DA4, 0 to 4).
1860H	G(P).OGSTOR instruction execution error	<ul style="list-style-type: none"> • Offset/gain setting mode • Wave output mode • The module is set as a target for the inter-module synchronization. The G(P).OGSTOR instruction is executed in one of the cases above.	Execute the G(P).OGSTOR instruction in the normal mode.
1861H	Offset/gain setting continuous write error	The G(P).OGSTOR instruction is continuously executed.	For the G(P).OGSTOR instruction, execute it only once per module.
		In the offset/gain setting, a setting value has been written to the flash memory more than 25 times consecutively.	Write the setting value into the flash memory only once for each offset/gain setting.
1862H	Model mismatch error at OGSTOR execution	The G(P).OGSTOR instruction has been executed on a module different from the one on which the G(P).OGLOAD instruction was executed.	Execute the G(P).OGLOAD and G(P).OGSTOR instructions on the same module.
		The G(P).OGSTOR instruction has been executed ahead of the G(P).OGLOAD instruction.	Execute the G(P).OGLOAD instruction on the module whose data is to be restored, and execute the G(P).OGSTOR instruction on the module to which the data is restored.
190□H	Range setting range error	A value outside the range is set in CH□ Range setting.	Set any of the following values in CH□ Range setting: R60DA4: 0 to 4, E, F (hexadecimal) R60DAV8: 0, 2 to 4, E (hexadecimal) R60DAI8: 0, 1, F (hexadecimal)

Error code	Error name	Description and cause	Action
191□H	Digital value setting range error	<ul style="list-style-type: none"> For normal output: A value outside the range is set for CH□ Digital value. 	Set an appropriate value for CH□ Digital value.
		<ul style="list-style-type: none"> For wave output: A value outside the setting range is set to part of 'Wave data registry area' (Un\G10000 to Un\G89999), which is used for a wave outputting channel. 	Set a value within the setting range to the corresponding area of 'Wave data registry area' (Un\G10000 to Un\G89999), which is used for the error channel.
1A0□H	Scaling enable/disable setting range error	A value other than 0 and 1 is set in CH□ Scaling enable/disable setting.	Set CH□ Scaling enable/disable setting to 0 or 1.
1A1□H	Scaling setting range error	A value other than -32000 to 32000 is set in CH□ Scaling lower limit value or CH□ Scaling upper limit value.	Set CH□ Scaling lower limit value and CH□ Scaling upper limit value to -32000 to 32000.
1A2□H	Scaling upper/lower limit value setting error	CH□ Scaling upper limit value is equal to CH□ Scaling lower limit value.	Set CH□ Scaling upper limit value and CH□ Scaling lower limit value as the scaling upper limit value ≠ the scaling lower limit value.
1B0□H	Alert output setting range error	A value other than 0 and 1 is set in CH□ Alert output setting.	Set CH□ Alert output setting to 0 or 1.
1B1□H	Alert output upper/lower limit value inversion error	Values that do not satisfy the following relation are set in CH□ Alert output upper limit value and CH□ Alert output lower limit value: Upper limit value > Lower limit value	Set values so that CH□ Alert output upper limit value is larger than CH□ Alert output lower limit value.
1B8□H	Rate control enable/disable setting range error	A value other than 0 and 1 is set in CH□ Rate control enable/disable setting.	Set 0 or 1 for CH□ Rate control enable/disable setting.
1B9□H	Digital limit value range error	A value other than 0 to 64000 is set in CH□ Increase digital limit value or CH□ Decrease digital limit value.	Set a value within 0 to 64000 in CH□ Increase digital limit value and CH□ Decrease digital limit value.
1C4□H	Disconnection detection error	A disconnection is detected in CH□.	Eliminate the cause of the disconnection of the corresponding channel, and turn on and off 'Error clear request' (YF).
1D0□H	Wave output start/stop setting range error	A value outside the range is set for CH□ Wave output start/stop request.	Set one of the following values to CH□ Wave output start/stop request. <ul style="list-style-type: none"> Wave output stop request (0) Wave output start request (1) Wave output pause request (2)
1D1□H	User range specification error in wave output mode	Wave output mode is selected in the output mode setting, and the user range setting is selected in the output range setting.	<ul style="list-style-type: none"> When using the wave output function, set a value other than the user range setting for the output range in the output range setting. If the user range setting is set, set the output mode setting to the normal output mode in the module parameter setting.
1D2□H	Output setting during wave output stop setting range error	A value outside the range of 0 to 2 is set to CH□ Output setting during wave output stop.	Set one of the following values to CH□ Output setting during wave output stop. <ul style="list-style-type: none"> 0V/0mA (0) Offset value (1) Setting value during stop (2)
1D3□H	Output value during wave output stop setting range error	A value outside the setting range is set in CH□ Output value during wave output stop.	Set CH□ Output value during wave output stop to fall within the range. The setting range varies depending on the setting of the output range. -10 to 10V: -32000 to 32000 4 to 20mA, 0 to 20mA, 1 to 5V, 0 to 5V: 0 to 32000
1D4□H	Wave pattern start address setting range error	A value outside the setting range is set in CH□ Wave pattern start address setting.	Set CH□ Wave pattern start address setting to 10000 to 89999.
1D5□H	Wave pattern data points setting range error	A value other than 1 to 80000 is set in CH□ Wave pattern data points setting.	Set CH□ Wave pattern data points setting to 1 to 80000.
1D6□H	Wave pattern output repetition setting range error	A value outside the setting range is set in CH□ Wave pattern output repetition setting.	Set one of the following values to CH□ Wave pattern output repetition setting. <ul style="list-style-type: none"> Unlimitedly repeat output (-1) Specified number of times (1 to 32767)
1D7□H	Wave output conversion cycle setting range error	A value outside the range of 1 to 5000 is set to CH□ Constant for wave output conversion cycle.	Set CH□ Constant for wave output conversion cycle to 1 to 5000.
1D80H	Step action wave output request range error	A value other than 0 and 1 is set to Step action wave output request.	Set 0 or 1 to Step action wave output request.

Error code	Error name	Description and cause	Action
1D9□H	Wave data registry area range error	The value obtained by subtracting 1 from the total value of CH□ Wave pattern start address setting and CH□ Wave pattern data points setting exceeds 89999 (the last buffer memory address of the wave data registry area).	Set values in CH□ Wave pattern start address setting and CH□ Wave pattern data points setting so that the following condition is satisfied: "Wave pattern start address setting" + "Wave pattern data points setting" - 1 ≤ 89999
1E50H	Offset/gain setting channel specification error	Multiple channels are set at the same time during the offset/gain setting. In the offset/gain setting, "1: Setting channel" is set for both CH□ Offset/gain setting mode (offset specification) and CH□ Offset/gain setting mode (gain specification), or "0: Disable" is set.	Correctly set CH□ Offset/gain setting mode (offset specification) and CH□ Offset/gain setting mode (gain specification).
1E51H	User range data invalid	An invalid value is set to the offset/gain setting. The number of an error channel cannot be identified.	Perform the offset/gain setting again for all channels where the user range is set. If the error occurs again, the possible cause is a failure of the module. Please consult your local Mitsubishi representative.
1E52H	Analog adjustment output setting out-of-range error	A value other than -3000 to 3000 is set to Offset/gain adjustment value specification.	Set a value within the range of -3000 to 3000 to Offset/gain adjustment value specification.
1E6□H	User range data invalid	An invalid value is set in CH□ Offset/gain setting.	Start over the offset/gain setting of the channel where the error has occurred. If the error occurs again, the possible cause is a failure of the module. Please consult your local Mitsubishi representative.
1E7□H	Offset/gain value inversion error	The offset value and gain value to be saved in the flash memory are as follows: Offset value ≥ Gain value	Perform the offset/gain setting again so that the following condition is satisfied: Offset value < Gain value
1E8□H	Offset/gain setting channel range error	A value other than 0 and 1 is set in CH□ Offset/gain setting mode (offset specification) and CH□ Offset/gain setting mode (gain specification).	Set CH□ Offset/gain setting mode (offset specification) and CH□ Offset/gain setting mode (gain specification) to 0 or 1.
1E9□H	Offset/gain setting range error	When the offset and gain are set, a value other than E or F is set for CH□ Offset/gain setting mode (range specification).	Set E or F for CH□ Offset/gain setting mode (range specification).
1EA0H	Synchronization cycle time setting lower limit error	The length of the D/A conversion cycle exceeds the length set in the inter-module synchronization cycle setting in the system parameter.	Set a long time in the inter-module synchronization cycle setting in the system parameters. As the other way, set unused D/A conversion enable channels to disable the conversion so that the following condition is satisfied: • Inter-module synchronization cycle setting > Run time of the inter-module synchronous interrupt program + D/A conversion time
1EA1H	Offset/gain setting error when the inter-module synchronization is selected	The module is set as a synchronization target, and offset/gain setting mode is set for the operation mode setting. As the other cause, a mode switching program has been executed during the synchronization normal output mode.	When using the synchronous normal output mode, set the operation mode setting to the normal mode (D/A conversion process). When performing the offset/gain setting, set the module as a synchronization non-target in the system parameters. In addition, do not execute a mode switching program during synchronization normal output mode.
1EA2H	Output selection error during an inter-module synchronization error	A value other than 0 or 1 is set in Output selection during a synchronization error.	Set a value of 0 or 1 in Output selection during a synchronization error.
1EA4H	Wave output mode setting error when the inter-module synchronization is selected	The module is set as a synchronization target, and wave output mode is set for the operation mode setting.	When using the synchronous normal output mode, set the operation mode setting to the normal mode (D/A conversion process). When using wave output mode, set the module to wave output mode in the system parameters.
2600H	Inter-module synchronization cross-cycles processing error	Processing over multiple cycles is detected with the inter-module synchronization function operating.	Set longer inter-module synchronization cycle or review the synchronization interrupt program such as reducing the number of steps.

Error code	Error name	Description and cause	Action
2601H	Inter-module synchronization cycle skipping error	Cycle skipping is detected with the inter-module synchronization function operating.	Execute the EI instruction in a main program to permit an interrupt. Set longer inter-module synchronization cycle or review the synchronization interrupt program such as reducing the number of steps. If the error reoccurs even after the adjustment, the possible cause is a failure of the module. Please consult your local Mitsubishi representative.
2610H	Inter-module synchronization signal error	Synchronization loss is detected with the inter-module synchronization function operating.	The module may be affected by noise. Review and adjust the cable wiring and the installation environment of the programmable controllers to restart the system. If the error reoccurs even after the adjustment, the possible cause is a failure of the module. Please consult your local Mitsubishi representative.
3001H	Hardware failure	A hardware failure has occurred in the module.	Power off and on the module. If the error occurs again, a failure might have occurred on the module. Please consult your local Mitsubishi representative.
3030H	Flash memory failure	The data in the flash memory is abnormal.	Check the analog output value. If there is an error, please consult your local Mitsubishi representative.

3.5 Alarm Code List

When an alarm occurs during operation, the D/A converter module stores an alarm code in 'Latest alarm code' (Un\G2) of the buffer memory. Turning on 'Alert output clear request' (YE) or 'Operating condition setting request' (Y9) clears the alarm code in 'Latest alarm code' (Un\G2).

The following table shows the list of the alarm codes stored.

□ in alarm codes: Indicates the channel of a generated error. A numerical value of 0 to 7 is used to correspond to channel 1 to 8.

(CH1: 0, CH2: 1, CH3: 2, CH4: 3, CH5: 4, CH6: 5, CH7: 6, CH8: 7)

Alarm code	Alarm name	Description and cause	Action
080□H	Alert output alarm (upper limit)	The alert output alarm (upper limit) has occurred in CH□.	Adjust CH□ Digital value to fall within the range, and turn on and off 'Alert output clear request' (YE). As a result, the corresponding bit of Alert output upper limit flag and/or Alert output lower limit flag, and 'Alert output signal' (XE) turn off.
081□H	Alert output alarm (lower limit)	The alert output alarm (lower limit) has occurred in CH□.	
0B0□H	Operating condition setting error except for wave output stop	'Operating condition setting request' (Y9) was turned on and off in a status other than Wave output stop.	Turn on and off 'Operating condition setting request' (Y9) after the wave output stops in all channels.
0B1□H	Scaling setting error in wave output mode	The scaling function is enabled when the wave output function is used.	Set CH□ Scaling enable/disable setting to Disable (1) when using the wave output function.
0B2□H	Input value shift amount setting error in wave output mode	A value other than 0 is set in Input value shift amount when the wave output function is used.	Set CH□ Input value shift amount to 0 when using the wave output function.
0B3□H	Rate control setting error in wave output mode	The rate control function is enabled when the wave output function is used.	Set CH□ Rate control enable/disable setting to Disable (1) when using the wave output function.
0C0□H	CH□ Under-output range change denial alarm	The range has been switched during analog output in CH□.	To switch the range, turn off Output enable/disable flag (Y1 to Y8) of the corresponding channel, and turn on and off Operating condition setting request (Y9).
0D00H	Inter-module synchronization mode shift request error	A mode switching request has been issued for a target module to be synchronized.	Target modules to be synchronized cannot shift to offset/gain mode. When performing the offset/gain setting, set the module as a synchronization non-target in the system parameters, and switch to normal output mode (D/A conversion processing) to shift to offset/gain mode. To clear the alarm, turn on and off 'Alert output clear request' (YE).
0D1□H	Inter-module synchronization rate control setting error	Rate control enable is set in CH□.	When an alarm is occurred, inter-module synchronization function can be operated, but rate control function becomes disabled. When using the rate control function, set the module as a synchronization non-target in the system parameters and set to normal output mode. To clear the alarm, set Disable in CH□ Rate control enable/disable and turn on and off 'Operating condition setting request' (Y9).

APPENDICES

Appendix 1 Module Label

The functions of the D/A converter module can be set by using module labels.

Module labels of I/O signals

The module label names of I/O signals are defined as follows.

"Module name"_"Module number".b"Label name" or "Module name"_"Module number".b"Label name"_D

Ex.

R60DA4_1.bModuleREADY_D

■Module name

The module model name

■Module number

A number starting from 1 for identifying modules that have the same module names.

■Label name

The label name unique to the module

■_D

Describes that the module label is the direct access input (DX) or direct access output (DY). When _D is not described, the module label is the input (X) or output (Y) of the refresh processing.

Module labels of buffer memory areas

The module labels of the buffer memory areas are defined as follows.

"Module name"_"Module number"."Data type"_D["(Channel)"]."Data type""Label name"_D

Ex.

R60DA_1.stnControl_D[0].wDigitalValue_D

■Module name

The module model name

■Module number

A number starting from 1 for identifying modules that have the same module names.

■Data type

Indicates the type of the buffer memory area. The following table shows the details.

Data type	Description
stnMonitor	Monitor
stnControl	Control
stnSetting	Setting

■Channel

Describes the channel number that corresponds to the module label. A numerical value of 0 to 7 is used to correspond to channel 1 to 8.

(CH1: 0, CH2: 1, CH3: 2, CH4: 3, CH5: 4, CH6: 5, CH7: 6, CH8: 7)

■Data type

Indicates the data size in the buffer memory area. The following table shows the details.

Data type	Description
u	Word [Unsigned]/Bit string [16-bit]
w	Word [Signed]

■Label name

The label name unique to the module

■_D

Describes that the module label is for the direct access. When _D is not described, the module label is for the auto refresh.

The following table shows the differences between the auto refresh and direct access.

Type	Description	Access timing	Example
Auto refresh	Reading/writing from/to the module label is reflected to the D/A converter module at the auto refresh in a batch. The run time of the program can be reduced. To use the auto refresh, set "Target" to the module label in "Refresh setting" of "Module parameter".	At auto refresh	R60DA_1.stnControl[0].wDigitalValue
Direct access	Reading/writing from/to the module label is immediately reflected to the D/A converter module. Compared with the auto refresh, the run time of the program becomes longer. However, the responsiveness is high.	At reading/writing from/to the module label	R60DA_1.stnControl_D[0].wDigitalValue_D

Appendix 2 I/O Signals

List of I/O signals

The following table lists the I/O signals of the D/A converter module.

For details on the I/O signals, refer to the following.

☞ Page 114 Details of input signals

☞ Page 121 Details of output signals

Point

- The I/O signals (X/Y) described below show the case that the start I/O number of the D/A converter module is set to "0".
- Do not use the "Use prohibited" signals shown below because the system uses them. If users use (turn off and on) the signals, the functions of the D/A converter module cannot be guaranteed.

Input signal

Device number	Signal name
X0	Module READY
X1 to X6	Use prohibited
X7	External power supply READY flag
X8	Use prohibited
X9	Operating condition setting completed flag
XA	Offset/gain setting mode status flag
XB	Channel change completed flag
XC	Set value change completed flag
XD	Disconnection detection signal
XE	Alert output signal
XF	Error flag

Output signal

Device number	Signal name
Y0	Use prohibited
Y1	CH1 Output enable/disable flag
Y2	CH2 Output enable/disable flag
Y3	CH3 Output enable/disable flag
Y4	CH4 Output enable/disable flag
Y5 ^{*1}	CH5 Output enable/disable flag
Y6 ^{*1}	CH6 Output enable/disable flag
Y7 ^{*1}	CH7 Output enable/disable flag
Y8 ^{*1}	CH8 Output enable/disable flag
Y9	Operating condition setting request
YA	User range write request
YB	Channel change request
YC	Value change request
YD	Use prohibited
YE	Alert output clear request
YF	Error clear request

*1 For the R60DA4, using Y5 to Y8 is prohibited.

Details of input signals

The following describes the details of the input signals for the D/A converter module which are assigned to the CPU module. The I/O numbers (X/Y) described in Appendix 2 are for the case when the start I/O number of the D/A converter module is set to 0.

Point

This section describes buffer memory addresses for CH1.

For details on the buffer memory addresses after CH2, refer to the following.

☞ Page 124 List of buffer memory addresses

Module READY

Module READY (X0) turns on to indicate the preparation for the D/A conversion is completed after the power-on or the reset operation of the CPU module.

In the following cases, 'Module READY' (X0) turns off.

- In the offset/gain setting mode (In this case, the D/A conversion is performed.)
- When a watchdog timer error occurs in the D/A converter module (In this case, the D/A conversion is not performed.)

■Device number

The following shows the device number of this input signal.

Signal name	CH1	CH2	CH3	CH4	CH5	CH6	CH7	CH8
Module READY	X0							

External power supply READY flag

■Device number

The following shows the device number of this input signal.

Signal name	CH1	CH2	CH3	CH4	CH5	CH6	CH7	CH8
External power supply READY flag	X7							

■When the external power supply is off, or when 200ms has not yet elapsed after the power-on

'External power supply READY flag' (X7) remains off and the D/A conversion is not performed.

In this case, the analog output value is 0V/0mA.

■When the external power supply is turned off and on

After 200ms, 'External power supply READY flag' (X7) turns on. The D/A conversion is started on the channels where the D/A conversion is enabled.

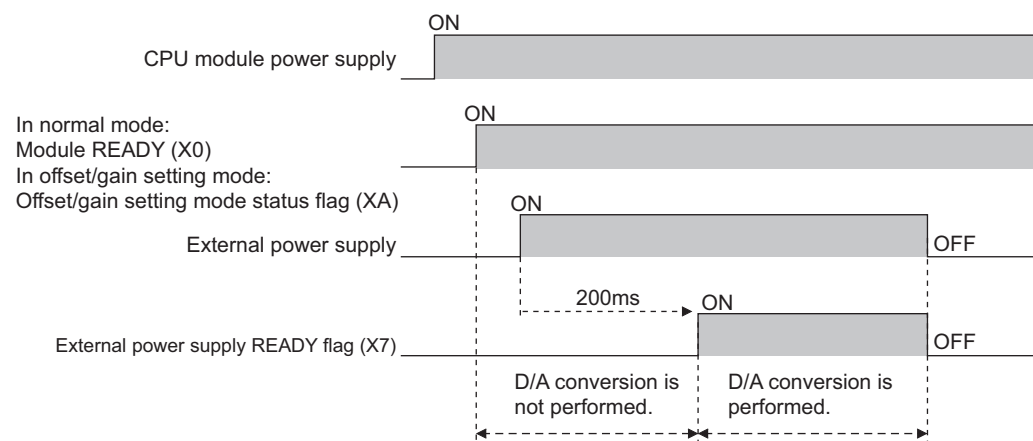

■When the external power supply is turned on and off

'External power supply READY flag' (X7) turns off and the D/A conversion stops.

In this case, the analog output value is 0V/0mA.

When the external power supply is turned off and on again, 'External power supply READY flag' (X7) turns on after 200ms as described above and the D/A conversion is restarted.

■Precautions

- Use the external power supply that satisfies the specifications described in the performance specifications. Otherwise, 'External power supply READY flag' (X7) does not turn on. For the performance specifications, refer to the following.

📖 MELSEC iQ-R Digital-Analog Converter Module User's Manual (Startup)

Operating condition setting completed flag

■Device number

The following shows the device number of this input signal.

Signal name	CH1	CH2	CH3	CH4	CH5	CH6	CH7	CH8
Operating condition setting completed flag	X9							

When changing the settings, use Operating condition setting completed flag (X9) as an interlock condition to turn on and off 'Operating condition setting request' (Y9).

For the buffer memory addresses which require turning on and off of 'Operating condition setting request' (Y9) to enable the changed values, refer to the following.

☞ Page 124 List of buffer memory addresses

In the following state, 'Operating condition setting completed flag' (X9) turns off.

- When 'Operating condition setting request' (Y9) is on

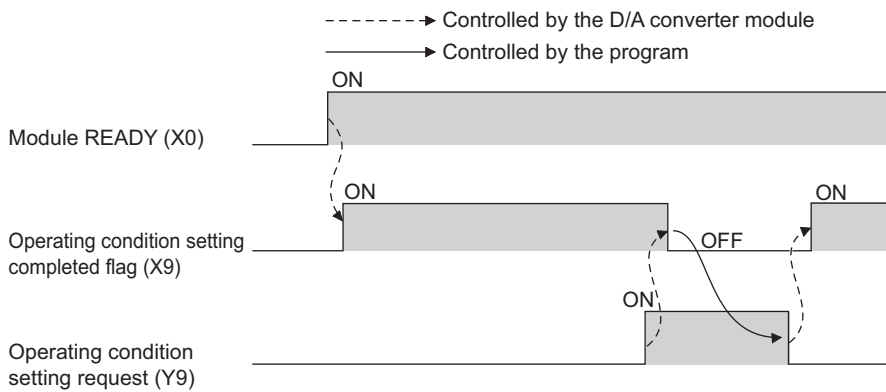

Offset/gain setting mode status flag

■Device number

The following shows the device number of this input signal.

Signal name	CH1	CH2	CH3	CH4	CH5	CH6	CH7	CH8
Offset/gain setting mode status flag	XA							

■In the offset/gain setting mode

When registering the offset or gain value that has been adjusted with the offset/gain setting, use Offset/gain setting mode status flag (XA) as an interlock condition to turn on and off 'User range write request' (YA).

For the offset/gain setting, refer to the following.

📖 MELSEC iQ-R Digital-Analog Converter Module User's Manual (Startup)

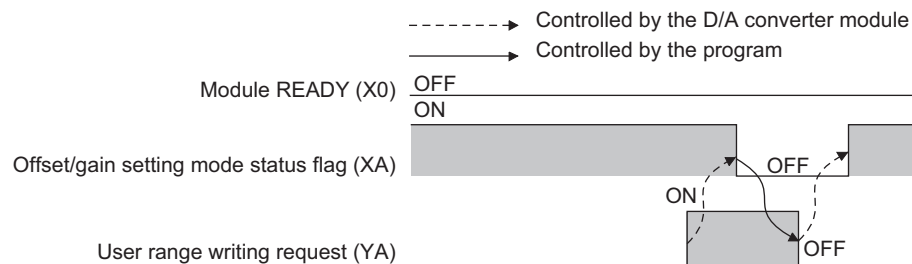

■In the normal mode

In the user range setting restoration, use Offset/gain setting mode status flag (XA) as an interlock condition to turn on and off User range write request (YA).

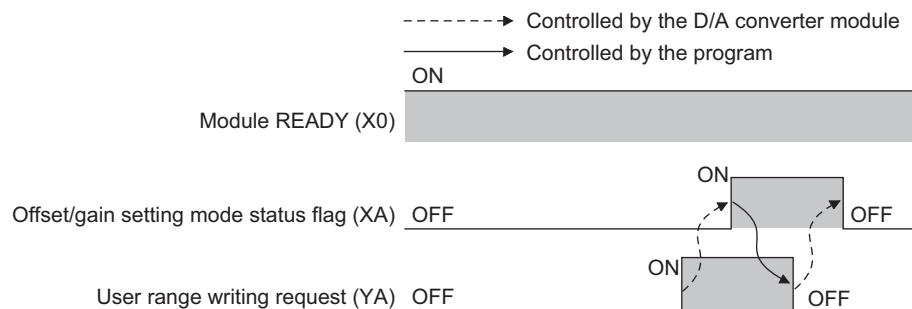

Channel change completed flag

When changing a channel to perform the offset/gain setting, use Channel change completed flag (XB) as an interlock condition to turn on and off 'Channel change request' (YB).

When the offset/gain setting is configured from the offset/gain setting window of an engineering tool, the setting is performed properly on the window. Therefore, a program is not required to perform the setting.

To configure the offset/gain setting creating a program, use this flag.

For details, refer to the following.

Digital-Analog Converter Module User's Manual

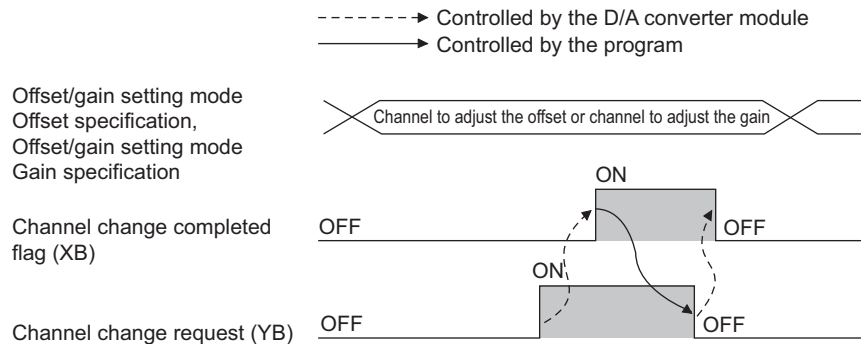

■Device number

The following shows the device number of this input signal.

Signal name	CH1	CH2	CH3	CH4	CH5	CH6	CH7	CH8
Channel change completed flag	XB							

Set value change completed flag

When adjusting the offset/gain setting, use Set value change completed flag (XC) as an interlock condition to turn on and off 'Value change request' (YC).

When the offset/gain setting is configured from the offset/gain setting window of an engineering tool, the setting is performed properly on the window. Therefore, a program is not required to perform the setting.

To configure the offset/gain setting creating a program, use this flag.

For details, refer to the following.

Digital-Analog Converter Module User's Manual

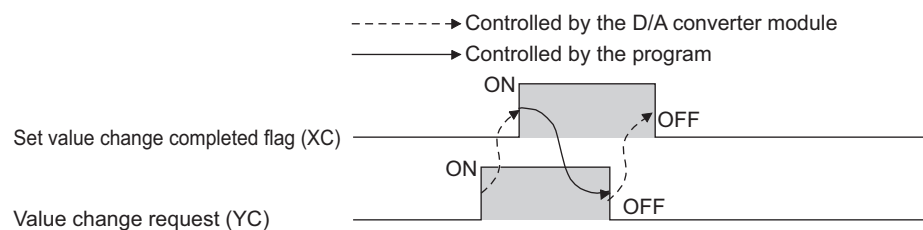

■Device number

The following shows the device number of this input signal.

Signal name	CH1	CH2	CH3	CH4	CH5	CH6	CH7	CH8
Set value change completed flag	XC							

■When the external power supply is off

'Set value change completed flag' (XC) does not turn on. Turn on the external power supply, and turn on and off 'Value change request' (YC) again.

Disconnection detection signal

Disconnection detection signal (XD) turns on when a disconnection is detected in a channel while the output range is 4 to 20mA.

'Disconnection detection signal' (XD) turns off by turning on and off 'Error clear request' (YF) or 'Operating condition setting request' (Y9) after the cause of the disconnection is eliminated.

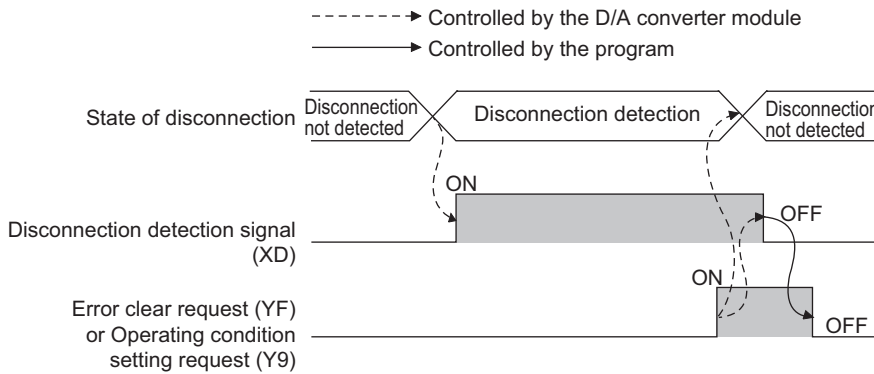

■Device number

The following shows the device number of this input signal.

Signal name	CH1	CH2	CH3	CH4	CH5	CH6	CH7	CH8
Disconnection detection signal	XD							

Alert output signal

Alert output signal turns on when the value in 'CH1 Digital value' (Un\G460) is larger than the value in 'CH1 Alert output upper limit value' (Un\G510) or is smaller than the value in 'CH1 Alert output lower limit value' (Un\G512) while the D/A conversion is enabled.

By turning on and off 'Alert output clear request' (YE) or turning off and on 'Operating condition setting request' (Y9) after the cause of the warning is eliminated, 'Alert output signal' (XE) turns off and 'Latest alarm code (Un\G2)' is cleared.

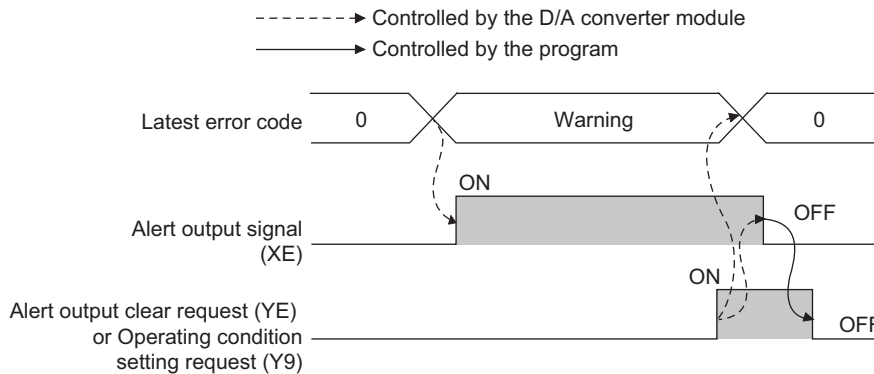

■Device number

The following shows the device number of this input signal.

Signal name	CH1	CH2	CH3	CH4	CH5	CH6	CH7	CH8
Alert output signal	XE							

Error flag

Error flag (XF) turns on when an error occurs.

By turning on and off 'Error clear request' (YF) after the cause of the error is eliminated, 'Error flag' (XE) turns off and 'Latest error code' (Un\G0) is cleared.

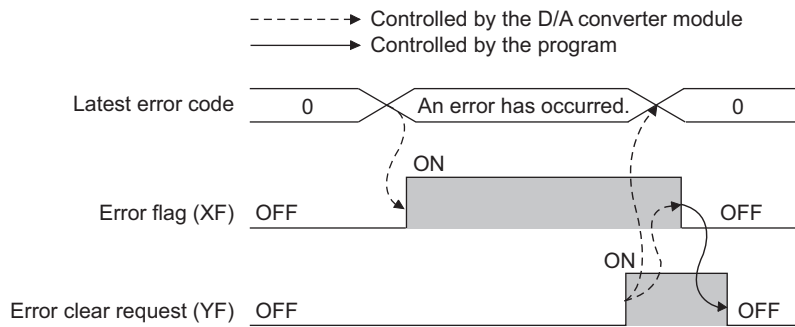

Device number

The following shows the device number of this input signal.

Signal name	CH1	CH2	CH3	CH4	CH5	CH6	CH7	CH8
Error flag	XF							

Details of output signals

The following describes the details of the output signals for the D/A converter module which are assigned to the CPU module. The I/O numbers (X/Y) described in Appendix 2 are for the case when the start I/O number of the D/A converter module is set to 0.

Point

This section describes I/O signals and buffer memory addresses for CH1.

For details on the buffer memory addresses after CH2, refer to the following.

☞ Page 124 List of buffer memory addresses

CH1 Output enable/disable flag

Set whether to output the D/A conversion value or offset value.

On: D/A conversion value

Off: Offset value

Device number

The following shows the device number of this input signal.

Signal name	CH1	CH2	CH3	CH4	CH5	CH6	CH7	CH8
CH□ Output enable/disable flag	Y1	Y2	Y3	Y4	Y5*1	Y6*1	Y7*1	Y8*1

*1 For the R60DA4, using Y5 to Y8 is prohibited.

Operating condition setting request

Turn on and off Operating condition setting request (Y9) to enable the setting of the buffer memory address.

For the buffer memory addresses which require turning on and off of 'Operating condition setting request' (Y9) to enable the changed values, refer to the following.

☞ Page 124 List of buffer memory addresses

For the timing of turning the signal on and off, refer to the following.

☞ Page 116 Operating condition setting completed flag

Device number

The following shows the device number of this input signal.

Signal name	CH1	CH2	CH3	CH4	CH5	CH6	CH7	CH8
Operating condition setting request	Y9							

User range write request

■Device number

The following shows the device number of this input signal.

Signal name	CH1	CH2	CH3	CH4	CH5	CH6	CH7	CH8
User range write request	YA							

■In the offset/gain setting mode

Turn on and off User range write request (YA) to register values adjusted with the offset/gain setting in the D/A converter module.

The data is written to the flash memory when this signal is turned off and on.

For the timing of turning the signal on and off, refer to the following.

☞ Page 117 Offset/gain setting mode status flag

For the offset/gain setting, refer to the following.

📖 MELSEC iQ-R Digital-Analog Converter Module User's Manual (Startup)

■Normal mode

Turn on and off User range write request (YA) to restore the user range setting.

For the timing of turning the signal on and off, refer to the following.

☞ Page 117 Offset/gain setting mode status flag

■In the wave output mode

The user range cannot be restored even when User range write request (YA) is turned on and off in the wave output mode. To restore the user range, set the module to the normal output mode.

Channel change request

Turn on and off Channel change request (YB) to change a channel to perform the offset/gain setting.

For the timing of turning the signal on and off, refer to the following.

☞ Page 118 Channel change completed flag

For the offset/gain setting, refer to the following.

📖 MELSEC iQ-R Digital-Analog Converter Module User's Manual (Startup)

■Device number

The following shows the device number of this input signal.

Signal name	CH1	CH2	CH3	CH4	CH5	CH6	CH7	CH8
Channel change request	YB							

Value change request

Turn on and off Value change request (YC) to change the analog output value to adjust the offset/gain setting.

The analog output value increases or decreases depending on the value set for the offset/gain adjustment value specification.

For the timing of turning the signal on and off, refer to the following.

☞ Page 118 Set value change completed flag

■Device number

The following shows the device number of this input signal.

Signal name	CH1	CH2	CH3	CH4	CH5	CH6	CH7	CH8
Value change request	YC							

Alert output clear request

Turn on and off 'Alert output clear request' (YE) to clear 'Alert output signal' (XE) and 'Latest alarm code' (Un\G2).
For the timing of turning the signal on and off, refer to the following.

☞ Page 119 Alert output signal

■Device number

The following shows the device number of this input signal.

Signal name	CH1	CH2	CH3	CH4	CH5	CH6	CH7	CH8
Alert output clear request	YE							

Error clear request

Turn on and off 'Error clear request' (YF) to clear 'Error flag' (XF) and 'Latest error code' (Un\G0).
For the timing of turning the signal on and off, refer to the following.

☞ Page 120 Error flag

■Device number

The following shows the device number of this input signal.

Signal name	CH1	CH2	CH3	CH4	CH5	CH6	CH7	CH8
Error clear request	YF							

Appendix 3 Buffer Memory

List of buffer memory addresses

The following table lists the buffer memory addresses of the D/A converter module.

For details on the buffer memory addresses, refer to the following.

-  Page 136 Details of buffer memory addresses

Point

Do not write data to the system areas and areas whose data types are monitor in the buffer memory. Writing data into these areas can cause the malfunction of the module.

When the R mode is used

■Un\G0 to Un\G399

Address (decimal)	Address (hexadecimal)	Name	Default value	Data type	Auto refresh	Enabled by Y9 ^{*1}
0	0H	Latest error code	0	Monitor	○	—
1	1H	Latest address of error history	0	Monitor	○	—
2	2H	Latest alarm code	0	Monitor	○	—
3	3H	Latest address of alarm history	0	Monitor	○	—
4 to 19	4H to 13H	Interrupt factor detection flag [n] ^{*2}	0	Monitor	○	—
20 to 35	14H to 23H	System area	—	—	—	—
36	24H	Alert output upper limit flag	0000H	Monitor	○	—
37	25H	Alert output lower limit flag	0000H	Monitor	○	—
38	26H	Disconnection detection flag	0000H	Monitor	○	—
39 to 59	27H to 3BH	System area	—	—	—	—
60	3CH	Output mode	0000H	Monitor	×	○
61 to 123	3DH to 7BH	System area	—	—	—	—
124 to 139	7CH to 8BH	Interrupt factor mask [n] ^{*2}	0	Control	×	—
140 to 155	8CH to 9BH	System area	—	—	—	—
156 to 171	9CH to ABH	Interrupt factor reset request [n] ^{*2}	0	Control	×	—
172 to 187	ACH to BBH	System area	—	—	—	—
188	BCH	Step action wave output request	0	Control	×	—
189 to 199	BDH to C7H	System area	—	—	—	—
200 to 215	C8H to D7H	Interrupt factor generation setting [n] ^{*2}	0	Setting	×	○
216 to 231	D8H to E7H	System area	—	—	—	—
232 to 247	E8H to F7H	Condition target setting [n] ^{*2}	0	Setting	×	○
248 to 263	F8H to 107H	System area	—	—	—	—
264 to 279	108H to 117H	Condition target channel setting [n] ^{*2}	0	Setting	×	○
280 to 295	118H to 127H	System area	—	—	—	—
296, 297	128H, 129H	Mode switching setting	0	Setting	×	○
298 to 399	12AH to 18FH	System area	—	—	—	—

*1 Item enabled by turning on and off 'Operating condition setting request' (Y9)

*2 [n] in the table indicates an interrupt setting number. (n = 1 to 16)

■Un\G400 to Un\G3599

Address Decimal (hexadecimal)								Name	Default value	Data type	Auto refresh	Enabled by Y9*1
CH1	CH2	CH3	CH4	CH5	CH6	CH7	CH8					
400 (190H)	600 (258H)	800 (320H)	1000 (3E8H)	1200 (4B0H)	1400 (578H)	1600 (640H)	1800 (708H)	CH□ Setting value check code	0	Monitor	○	—
401 (191H)	601 (259H)	801 (321H)	1001 (3E9H)	1201 (4B1H)	1401 (579H)	1601 (641H)	1801 (709H)	CH□ Wave output status monitor	0	Monitor	○	—
402 to 429 (192H to 1ADH)	602 to 629 (25AH to 275H)	802 to 829 (322H to 33DH)	1002 to 1029 (3EAH to 405H)	1202 to 1229 (4B2H to 4CDH)	1402 to 1429 (57AH to 595H)	1602 to 1629 (642H to 65DH)	1802 to 1829 (70AH to 725H)	System area	—	—	—	—
430 (1AEH)	630 (276H)	830 (33EH)	1030 (406H)	1230 (4CEH)	1430 (596H)	1630 (65EH)	1830 (726H)	CH□ Range setting monitor	0*2 2*3	Monitor	×	—
431 (1AFH)	631 (277H)	831 (33FH)	1031 (407H)	1231 (4CFH)	1431 (597H)	1631 (65FH)	1831 (727H)	CH□ HOLD/CLEAR function setting monitor	0	Monitor	×	—
432 (1B0H)	632 (278H)	832 (340H)	1032 (408H)	1232 (4D0H)	1432 (598H)	1632 (660H)	1832 (728H)	CH□ Wave output conversion cycle monitor (L)	0	Monitor	×	—
433 (1B1H)	633 (279H)	833 (341H)	1033 (409H)	1233 (4D1H)	1433 (599H)	1633 (661H)	1833 (729H)	CH□ Wave output conversion cycle monitor (H)		Monitor	×	—
434 (1B2H)	634 (27AH)	834 (342H)	1034 (40AH)	1234 (4D2H)	1434 (59AH)	1634 (662H)	1834 (72AH)	CH□ Wave pattern output count monitor	0	Monitor	×	—
435 (1B3H)	635 (27BH)	835 (343H)	1035 (40BH)	1235 (4D3H)	1435 (59BH)	1635 (663H)	1835 (72BH)	System area	—	—	—	—
436 (1B4H)	636 (27CH)	836 (344H)	1036 (40CH)	1236 (4D4H)	1436 (59CH)	1636 (664H)	1836 (72CH)	CH□ Wave output current address monitor (L)	0	Monitor	×	—
437 (1B5H)	637 (27DH)	837 (345H)	1037 (40DH)	1237 (4D5H)	1437 (59DH)	1637 (665H)	1837 (72DH)	CH□ Wave output current address monitor (H)		Monitor	×	—
438 (1B6H)	638 (27EH)	838 (346H)	1038 (40EH)	1238 (4D6H)	1438 (59EH)	1638 (666H)	1838 (72EH)	CH□ Wave output current digital value monitor	0	Monitor	×	—
439 (1B7H)	639 (27FH)	839 (347H)	1039 (40FH)	1239 (4D7H)	1439 (59FH)	1639 (667H)	1839 (72FH)	System area	—	—	—	—
440 (1B8H)	640 (280H)	840 (348H)	1040 (410H)	1240 (4D8H)	1440 (5A0H)	1640 (668H)	1840 (730H)	CH□ Wave output digital value out-of-range address monitor (L)	0	Monitor	×	—
441 (1B9H)	641 (281H)	841 (349H)	1041 (411H)	1241 (4D9H)	1441 (5A1H)	1641 (669H)	1841 (731H)	CH□ Wave output digital value out-of-range address monitor (H)		Monitor	×	—
442 (1BAH)	642 (282H)	842 (34AH)	1042 (412H)	1242 (4DAH)	1442 (5A2H)	1642 (66AH)	1842 (732H)	CH□ Wave output warning address monitor (L)	0	Monitor	×	—
443 (1BBH)	643 (283H)	843 (34BH)	1043 (413H)	1243 (4DBH)	1443 (5A3H)	1643 (66BH)	1843 (733H)	CH□ Wave output warning address monitor (H)		Monitor	×	—
444 to 459 (1BCH to 1CBH)	644 to 659 (284H to 293H)	844 to 859 (34CH to 35BH)	1044 to 1059 (414H to 423H)	1244 to 1259 (4DCH to 4EBH)	1444 to 1459 (5A4H to 5B3H)	1644 to 1659 (66CH to 67BH)	1844 to 1859 (734H to 743H)	System area	—	—	—	—
460 (1CCH)	660 (294H)	860 (35CH)	1060 (424H)	1260 (4ECH)	1460 (5B4H)	1660 (67CH)	1860 (744H)	CH□ Digital value	0	Control	○	—
461 (1CDH)	661 (295H)	861 (35DH)	1061 (425H)	1261 (4EDH)	1461 (5B5H)	1661 (67DH)	1861 (745H)	System area	—	—	—	—
462 (1CEH)	662 (296H)	862 (35EH)	1062 (426H)	1262 (4EEH)	1462 (5B6H)	1662 (67EH)	1862 (746H)	CH□ Wave output start/ stop request	0	Control	×	—
463 to 479 (1CFH to 1DFH)	663 to 679 (297H to 2A7H)	863 to 879 (35FH to 36FH)	1063 to 1079 (427H to 437H)	1263 to 1279 (4EFH to 4FFH)	1463 to 1479 (5B7H to 5C7H)	1663 to 1679 (67FH to 68FH)	1863 to 1879 (747H to 757H)	System area	—	—	—	—
480 (1E0H)	680 (2A8H)	880 (370H)	1080 (438H)	1280 (500H)	1480 (5C8H)	1680 (690H)	1880 (758H)	CH□ Input value shift amount	0	Control	×	—

Address Decimal (hexadecimal)								Name	Default value	Data type	Auto refresh	Enabled by Y9*1
CH1	CH2	CH3	CH4	CH5	CH6	CH7	CH8					
481 (1E1H)	681 (2A9H)	881 (371H)	1081 (439H)	1281 (501H)	1481 (5C9H)	1681 (691H)	1881 (759H)	System area	—	—	—	—
482 (1E2H)	682 (2AAH)	882 (372H)	1082 (43AH)	1282 (502H)	1482 (5CAH)	1682 (692H)	1882 (75AH)	CH□ Wave output step action movement amount	0	Control	×	—
483 to 499 (1E3H to 1F3H)	683 to 699 (2ABH to 2BBH)	883 to 899 (373H to 383H)	1083 to 1099 (43BH to 44BH)	1283 to 1299 (503H to 513H)	1483 to 1499 (5CBH to 5DBH)	1683 to 1699 (693H to 6A3H)	1883 to 1899 (75BH to 76BH)	System area	—	—	—	—
500 (1F4H)	700 (2BCH)	900 (384H)	1100 (44CH)	1300 (514H)	1500 (5DCH)	1700 (6A4H)	1900 (76CH)	CH□ D/A conversion enable/disable setting	1	Setting	×	○
501 (1F5H)	701 (2BDH)	901 (385H)	1101 (44DH)	1301 (515H)	1501 (5DDH)	1701 (6A5H)	1901 (76DH)	System area	—	—	—	—
502 (1F6H)	702 (2BEH)	902 (386H)	1102 (44EH)	1302 (516H)	1502 (5DEH)	1702 (6A6H)	1902 (76EH)	CH□ Scaling enable/ disable setting	1	Setting	×	○
503 (1F7H)	703 (2BFH)	903 (387H)	1103 (44FH)	1303 (517H)	1503 (5DFH)	1703 (6A7H)	1903 (76FH)	System area	—	—	—	—
504 (1F8H)	704 (2C0H)	904 (388H)	1104 (450H)	1304 (518H)	1504 (5E0H)	1704 (6A8H)	1904 (770H)	CH□ Scaling upper limit value	0	Setting	×	○
505 (1F9H)	705 (2C1H)	905 (389H)	1105 (451H)	1305 (519H)	1505 (5E1H)	1705 (6A9H)	1905 (771H)	System area	—	—	—	—
506 (1FAH)	706 (2C2H)	906 (38AH)	1106 (452H)	1306 (51AH)	1506 (5E2H)	1706 (6AAH)	1906 (772H)	CH□ Scaling lower limit value	0	Setting	×	○
507 (1FBH)	707 (2C3H)	907 (38BH)	1107 (453H)	1307 (51BH)	1507 (5E3H)	1707 (6ABH)	1907 (773H)	System area	—	—	—	—
508 (1FCH)	708 (2C4H)	908 (38CH)	1108 (454H)	1308 (51CH)	1508 (5E4H)	1708 (6ACH)	1908 (774H)	CH□ Alert output setting	1	Setting	×	○
509 (1FDH)	709 (2C5H)	909 (38DH)	1109 (455H)	1309 (51DH)	1509 (5E5H)	1709 (6ADH)	1909 (775H)	CH□ Rate control enable/ disable setting	1	Setting	×	○
510 (1FEH)	710 (2C6H)	910 (38EH)	1110 (456H)	1310 (51EH)	1510 (5E6H)	1710 (6AEH)	1910 (776H)	CH□ Alert output upper limit value	0	Setting	×	○
511 (1FFH)	711 (2C7H)	911 (38FH)	1111 (457H)	1311 (51FH)	1511 (5E7H)	1711 (6AFH)	1911 (777H)	System area	—	—	—	—
512 (200H)	712 (2C8H)	912 (390H)	1112 (458H)	1312 (520H)	1512 (5E8H)	1712 (6B0H)	1912 (778H)	CH□ Alert output lower limit value	0	Setting	×	○
513 (201H)	713 (2C9H)	913 (391H)	1113 (459H)	1313 (521H)	1513 (5E9H)	1713 (6B1H)	1913 (779H)	System area	—	—	—	—
514 (202H)	714 (2CAH)	914 (392H)	1114 (45AH)	1314 (522H)	1514 (5EAH)	1714 (6B2H)	1914 (77AH)	CH□ Increase digital limit value	64000	Setting	×	○
515 (203H)	715 (2CBH)	915 (393H)	1115 (45BH)	1315 (523H)	1515 (5EBH)	1715 (6B3H)	1915 (77BH)	System area	—	—	—	—
516 (204H)	716 (2CCH)	916 (394H)	1116 (45CH)	1316 (524H)	1516 (5ECH)	1716 (6B4H)	1916 (77CH)	CH□ Decrease digital limit value	64000	Setting	×	○
517 to 523 (205H to 20BH)	717 to 723 (2CDH to 2D3H)	917 to 923 (395H to 39BH)	1117 to 1123 (45DH to 463H)	1317 to 1323 (525H to 52BH)	1517 to 1523 (5EDH to 5F3H)	1717 to 1723 (6B5H to 6BBH)	1917 to 1923 (77DH to 783H)	System area	—	—	—	—
524 (20CH)	724 (2D4H)	924 (39CH)	1124 (464H)	1324 (52CH)	1524 (5F4H)	1724 (6BCH)	1924 (784H)	CH□ Output setting during wave output stop	1	Setting	×	—
525 (20DH)	725 (2D5H)	925 (39DH)	1125 (465H)	1325 (52DH)	1525 (5F5H)	1725 (6BDH)	1925 (785H)	CH□ Output value during wave output stop	0	Setting	×	—
526 (20EH)	726 (2D6H)	926 (39EH)	1126 (466H)	1326 (52EH)	1526 (5F6H)	1726 (6BEH)	1926 (786H)	CH□ Wave pattern start address setting (L)	10000	Setting	×	—
527 (20FH)	727 (2D7H)	927 (39FH)	1127 (467H)	1327 (52FH)	1527 (5F7H)	1727 (6BFH)	1927 (787H)	CH□ Wave pattern start address setting (H)		Setting	×	—

Address Decimal (hexadecimal)								Name	Default value	Data type	Auto refresh	Enabled by Y9*1
CH1	CH2	CH3	CH4	CH5	CH6	CH7	CH8					
528 (210H)	728 (2D8H)	928 (3A0H)	1128 (468H)	1328 (530H)	1528 (5F8H)	1728 (6C0H)	1928 (788H)	CH□ Wave pattern data points setting (L)	0	Setting	×	—
529 (211H)	729 (2D9H)	929 (3A1H)	1129 (469H)	1329 (531H)	1529 (5F9H)	1729 (6C1H)	1929 (789H)			CH□ Wave pattern data points setting (H)	Setting	×
530 (212H)	730 (2DAH)	930 (3A2H)	1130 (46AH)	1330 (532H)	1530 (5FAH)	1730 (6C2H)	1930 (78AH)	CH□ Wave pattern output repetition setting	1	Setting	×	—
531 (213H)	731 (2DBH)	931 (3A3H)	1131 (46BH)	1331 (533H)	1531 (5FBH)	1731 (6C3H)	1931 (78BH)	CH□ Constant for wave output conversion cycle	1	Setting	×	—
532 to 597 (214H to 255H)	732 to 797 (2DCH to 31DH)	932 to 997 (3A4H to 3E5H)	1132 to 1197 (46CH to 4ADH)	1332 to 1397 (534H to 575H)	1532 to 1597 (5FCH to 63DH)	1732 to 1797 (6C4H to 705H)	1932 to 1997 (78CH to 7CDH)	System area	—	—	—	—
598 (256H)	798 (31EH)	998 (3E6H)	1198 (4AEH)	1398 (576H)	1598 (63EH)	1798 (706H)	1998 (7CEH)	CH□ Range setting	0	Setting	×	○
599 (257H)	799 (31FH)	999 (3E7H)	1199 (4AFH)	1399 (577H)	1599 (63FH)	1799 (707H)	1999 (7CFH)	System area	—	—	—	—
2000 to 3599 (7D0H to E0FH)								System area	—	—	—	—

*1 Item enabled by turning on and off 'Operating condition setting request' (Y9)

*2 For the R60DA4 or R60DAI8

*3 For the R60DAV8

■Error history (Un\G3600 to Un\G3759)

Address (decimal)	Address (hexadecimal)	Name			Default value	Data type	Auto refresh	Enabled by Y9*1	
3600	E10H	Error history No.1	Error code			0	Monitor	×	—
3601	E11H		Error time	First two digits of the year	Last two digits of the year				
3602	E12H			Month	Day				
3603	E13H			Hour	Minute				
3604	E14H			Second	Day of the week				
3605	E15H			Millisecond					
3606 to 3609	E16H to E19H	System area			—	—	—	—	
3610 to 3615	E1AH to E1FH	Error history No.2	Same as error history No.1			0	Monitor	×	—
3616 to 3619	E20H to E23H	System area			—	—	—	—	
3620 to 3625	E24H to E29H	Error history No.3	Same as error history No.1			0	Monitor	×	—
3626 to 3629	E2AH to E2DH	System area			—	—	—	—	
3630 to 3635	E2EH to E33H	Error history No.4	Same as error history No.1			0	Monitor	×	—
3636 to 3639	E34H to E37H	System area			—	—	—	—	
3640 to 3645	E38H to E3DH	Error history No.5	Same as error history No.1			0	Monitor	×	—
3646 to 3649	E3EH to E41H	System area			—	—	—	—	
3650 to 3655	E42H to E47H	Error history No.6	Same as error history No.1			0	Monitor	×	—
3656 to 3659	E48H to E4BH	System area			—	—	—	—	
3660 to 3665	E4CH to E51H	Error history No.7	Same as error history No.1			0	Monitor	×	—
3666 to 3669	E52H to E55H	System area			—	—	—	—	
3670 to 3675	E56H to E5BH	Error history No.8	Same as error history No.1			0	Monitor	×	—
3676 to 3679	E5CH to E5FH	System area			—	—	—	—	
3680 to 3685	E60H to E65H	Error history No.9	Same as error history No.1			0	Monitor	×	—
3686 to 3689	E66H to E69H	System area			—	—	—	—	
3690 to 3695	E6AH to E6FH	Error history No.10	Same as error history No.1			0	Monitor	×	—
3696 to 3699	E70H to E73H	System area			—	—	—	—	
3700 to 3705	E74H to E79H	Error history No.11	Same as error history No.1			0	Monitor	×	—
3706 to 3709	E7AH to E7DH	System area			—	—	—	—	
3710 to 3715	E7EH to E83H	Error history No.12	Same as error history No.1			0	Monitor	×	—
3716 to 3719	E84H to E87H	System area			—	—	—	—	
3720 to 3725	E88H to E8DH	Error history No.13	Same as error history No.1			0	Monitor	×	—
3726 to 3729	E8EH to E91H	System area			—	—	—	—	
3730 to 3735	E92H to E97H	Error history No.14	Same as error history No.1			0	Monitor	×	—
3736 to 3739	E98H to E9BH	System area			—	—	—	—	
3740 to 3745	E9CH to EA1H	Error history No.15	Same as error history No.1			0	Monitor	×	—
3746 to 3749	EA2H to EA5H	System area			—	—	—	—	
3750 to 3755	EA6H to EABH	Error history No.16	Same as error history No.1			0	Monitor	×	—
3756 to 3759	EACH to EAFH	System area			—	—	—	—	

*1 Item enabled by turning on and off 'Operating condition setting request' (Y9)

■ Alarm history (Un\G3760 to Un\G3999)

Address (decimal)	Address (hexadecimal)	Name			Default value	Data type	Auto refresh	Enabled by Y9 ^{*1}	
3760	EB0H	Alarm history No.1	Alarm code		0	Monitor	×	—	
3761	EB1H		Alarm time	First two digits of the year					Last two digits of the year
3762	EB2H			Month					Day
3763	EB3H			Hour					Minute
3764	EB4H			Second					Day of the week
3765	EB5H			Millisecond					
3766 to 3769	EB6H to EB9H	System area			—	—	—	—	
3770 to 3775	EBAH to EBFH	Alarm history No.2	Same as alarm history No.1		0	Monitor	×	—	
3776 to 3779	EC0H to EC3H	System area			—	—	—	—	
3780 to 3785	EC4H to EC9H	Alarm history No.3	Same as alarm history No.1		0	Monitor	×	—	
3786 to 3789	ECAH to ECDH	System area			—	—	—	—	
3790 to 3795	ECEH to ED3H	Alarm history No.4	Same as alarm history No.1		0	Monitor	×	—	
3796 to 3799	ED4H to ED7H	System area			—	—	—	—	
3800 to 3805	ED8H to EDDH	Alarm history No.5	Same as alarm history No.1		0	Monitor	×	—	
3806 to 3809	EDEH to EE1H	System area			—	—	—	—	
3810 to 3815	EE2H to EE7H	Alarm history No.6	Same as alarm history No.1		0	Monitor	×	—	
3816 to 3819	EE8H to EEBH	System area			—	—	—	—	
3820 to 3825	EECH to EF1H	Alarm history No.7	Same as alarm history No.1		0	Monitor	×	—	
3826 to 3829	EF2H to EF5H	System area			—	—	—	—	
3830 to 3835	EF6H to EFBH	Alarm history No.8	Same as alarm history No.1		0	Monitor	×	—	
3836 to 3839	EFCH to EFFH	System area			—	—	—	—	
3840 to 3845	F00H to F05H	Alarm history No.9	Same as alarm history No.1		0	Monitor	×	—	
3846 to 3849	F06H to F09H	System area			—	—	—	—	
3850 to 3855	F0AH to F0FH	Alarm history No.10	Same as alarm history No.1		0	Monitor	×	—	
3856 to 3859	F10H to F13H	System area			—	—	—	—	
3860 to 3865	F14H to F19H	Alarm history No.11	Same as alarm history No.1		0	Monitor	×	—	
3866 to 3869	F1AH to F1DH	System area			—	—	—	—	
3870 to 3875	F1EH to F23H	Alarm history No.12	Same as alarm history No.1		0	Monitor	×	—	
3876 to 3879	F24H to F27H	System area			—	—	—	—	
3880 to 3885	F28H to F2DH	Alarm history No.13	Same as alarm history No.1		0	Monitor	×	—	
3886 to 3889	F2EH to F31H	System area			—	—	—	—	
3890 to 3895	F32H to F37H	Alarm history No.14	Same as alarm history No.1		0	Monitor	×	—	
3896 to 3899	F38H to F3BH	System area			—	—	—	—	
3900 to 3905	F3CH to F41H	Alarm history No.15	Same as alarm history No.1		0	Monitor	×	—	
3906 to 3909	F42H to F45H	System area			—	—	—	—	
3910 to 3915	F46H to F4BH	Alarm history No.16	Same as alarm history No.1		0	Monitor	×	—	
3916 to 3999	F4CH to F9FH	System area			—	—	—	—	

*1 Item enabled by turning on and off 'Operating condition setting request' (Y9)

A

■Offset/gain setting (For R60DA4) (Un\G4000 to Un\G4129)

Address Decimal (hexadecimal)				Name	Default value	Data type	Auto refresh	Enabled by Y9*1
CH1	CH2	CH3	CH4					
4000 to 4001 (FA0H to FA1H)				System area	—	—	—	—
4002 (FA2H)				Save data type setting	0000H	Setting	×	○
4003 (FA3H)				System area	—	—	—	—
4004 (FA4H)	4006 (FA6H)	4008 (FA8H)	4010 (FAAH)	CH□ Factory default setting offset value	0	Setting	×	—
4005 (FA5H)	4007 (FA7H)	4009 (FA9H)	4011 (FABH)	CH□ Factory default setting gain value	0	Setting	×	—
4012 (FACH)	4014 (FAEH)	4016 (FB0H)	4018 (FB2H)	CH□ User range setting offset value	0	Setting	×	—
4013 (FADH)	4015 (FAFH)	4017 (FB1H)	4019 (FB3H)	CH□ User range setting gain value	0	Setting	×	—
4020 to 4129 (FB4H to 1021H)				System area	—	—	—	—

*1 Item enabled by turning on and off 'Operating condition setting request' (Y9)

■Offset/gain setting (For R60DAV8 and R60DAI8) (Un\G4000 to Un\G4129)

Address Decimal (hexadecimal)								Name	Default value	Data type	Auto refresh	Enabled by Y9*1
CH1	CH2	CH3	CH4	CH5	CH6	CH7	CH8					
4000 to 4003 (FA0H to FA3H)								System area	—	—	—	—
4004 (FA4H)	4006 (FA6H)	4008 (FA8H)	4010 (FAAH)	4012 (FACH)	4014 (FAEH)	4016 (FB0H)	4018 (FB2H)	CH□ Factory default setting offset value	0	Setting	×	—
4005 (FA5H)	4007 (FA7H)	4009 (FA9H)	4011 (FABH)	4013 (FADH)	4015 (FAFH)	4017 (FB1H)	4019 (FB3H)	CH□ Factory default setting gain value	0	Setting	×	—
4020 (FB4H)	4022 (FB6H)	4024 (FB8H)	4026 (FBAH)	4028 (FBCH)	4030 (FBEH)	4032 (FC0H)	4034 (FC2H)	CH□ User range setting offset value	0	Setting	×	—
4021 (FB5H)	4023 (FB7H)	4025 (FB9H)	4027 (FBBH)	4029 (FBDH)	4031 (FBFH)	4033 (FC1H)	4035 (FC3H)	CH□ User range setting gain value	0	Setting	×	—
4036 to 4129 (FC4H to 1021H)								System area	—	—	—	—

*1 Item enabled by turning on and off 'Operating condition setting request' (Y9)

■Un\G4130 to Un\G89999

Address Decimal (hexadecimal)								Name	Default t value	Data type	Auto refresh	Enabled by Y9 ^{*1}
CH1	CH2	CH3	CH4	CH5	CH6	CH7	CH8					
4130 (1022H)								Offset/gain adjustment value specification	0	Control	×	—
4131 (1023H)								System area	—	—	—	—
4132 (1024H)	4134 (1026H)	4136 (1028H)	4138 (102AH)	4140 (102CH)	4142 (102EH)	4144 (1030H)	4146 (1032H)	CH□ Offset/gain setting mode (offset specification)	0	Setting	×	—
4133 (1025H)	4135 (1027H)	4137 (1029H)	4139 (102BH)	4141 (102DH)	4143 (102FH)	4145 (1031H)	4147 (1033H)	CH□ Offset/gain setting mode (gain specification)	0	Setting	×	—
4148 to 4163 (1034H to 1043H)								System area	—	—	—	—
4164 (1044H)	4165 (1045H)	4166 (1046H)	4167 (1047H)	4168 (1048H)	4169 (1049H)	4170 (104AH)	4171 (104BH)	CH□ Offset/gain setting mode (range specification)	0	Setting	×	—
4172 to 9499 (104CH to 251BH)								System area	—	—	—	—
9500 (251CH)	9502 (251EH)	9504 (2520H)	9506 (2522H)	9508 (2524H)	9510 (2526H)	9512 (2528H)	9514 (252AH)	CH□ Synchronization digital value	0	Control	○	—
9501 (251DH)	9503 (251FH)	9505 (2521H)	9507 (2523H)	9509 (2525H)	9511 (2527H)	9513 (2529H)	9515 (252BH)	System area	—	—	—	—
9516 to 9531 (252CH to 253BH)								System area	—	—	—	—
9532 (253CH)								Output setting during synchronous Error	0	Setting	×	○
9533 to 9599 (253DH to 257FH)								System area	—	—	—	—
9600 (2580H)								Synchronization status monitor	0	Monitor	○	—
9601 to 9999 (2581H to 270FH)								System area	—	—	—	—
10000 to 89999 (2710H to 15F8FH)								Wave data registry area	0	Setting	×	—

*1 Item enabled by turning on and off 'Operating condition setting request' (Y9)

A

When the Q compatible mode function is used

■Un\G0 to Un\G199

Address Decimal (hexadecimal)								Name	Default value	Data type	Auto refresh	Enabled by Y9*1
CH1	CH2	CH3	CH4	CH5	CH6	CH7	CH8					
0 (0H)								D/A conversion enable/disable setting	00FFH	Setting	×	○
1 (1H)	2 (2H)	3 (3H)	4 (4H)	5 (5H)	6 (6H)	7 (7H)	8 (8H)	CH□ Digital value	0	Control	○	—
9 (9H)								Output mode	0000H	Monitor	×	—
10 (AH)								System area	—	—	—	—
11 (BH)	12 (CH)	13 (DH)	14 (EH)	15 (FH)	16 (10H)	17 (11H)	18 (12H)	CH□ Setting value check code	0	Monitor	○	—
19 (13H)								Latest error code	0	Monitor	○	—
20 (14H)				21 (15H)				Range setting monitor	0000H ²	Monitor	×	—
									2222H ³			—
22 (16H)								Offset/gain setting mode (offset specification)	0000H	Setting	×	—
23 (17H)								Offset/gain setting mode (gain specification)	0000H	Setting	×	—
24 (18H)								Offset/gain adjustment value specification	0	Control	×	—
25 (19H)								Offset/gain setting mode (range specification)	0000H	Setting	×	—
26 (1AH)				27 (1BH)				HOLD/CLEAR function setting monitor	0000H	Monitor	×	—
28 to 45 (1CH to 2DH)								System area	—	—	—	—
46 (2EH)								Rate control enable/ disable setting	00FFH	Setting	×	○
47 (2FH)								Alert output setting	00FFH	Setting	×	○
48 (30H)								Alert output flag	0000H	Monitor	○	—
49 (31H)								Disconnection detection flag	0000H	Monitor	○	—
50 to 52 (32H to 34H)								System area	—	—	—	—
53 (35H)								CH□ Scaling enable/ disable setting	00FFH	Setting	×	○
54 (36H)	56 (38H)	58 (3AH)	60 (3CH)	62 (3EH)	64 (40H)	66 (42H)	68 (44H)	CH□ Scaling lower limit value	0	Setting	×	○
55 (37H)	57 (39H)	59 (3BH)	61 (3DH)	63 (3FH)	65 (41H)	67 (43H)	69 (45H)	CH□ Scaling upper limit value	0	Setting	×	○
70 (46H)	72 (48H)	74 (4AH)	76 (4CH)	78 (4EH)	80 (50H)	82 (52H)	84 (54H)	CH□ Increase digital limit value	64000	Setting	×	○
71 (47H)	73 (49H)	75 (4BH)	77 (4DH)	79 (4FH)	81 (51H)	83 (53H)	85 (55H)	CH□ Decrease digital limit value	64000	Setting	×	○
86 (56H)	88 (58H)	90 (5AH)	92 (5CH)	94 (5EH)	96 (60H)	98 (62H)	100 (64H)	CH□ Alert output upper limit value	0	Setting	×	○
87 (57H)	89 (59H)	91 (5BH)	93 (5DH)	95 (5FH)	97 (61H)	99 (63H)	101 (65H)	CH□ Alert output lower limit value	0	Setting	×	○
102 to 149 (66H to 95H)								System area	—	—	—	—
150 (96H)	151 (97H)	152 (98H)	153 (99H)	154 (9AH)	155 (9BH)	156 (9CH)	157 (9DH)	CH□ Input value shift amount	0	Control	×	—

Address Decimal (hexadecimal)								Name	Default value	Data type	Auto refresh	Enabled by Y9*1
CH1	CH2	CH3	CH4	CH5	CH6	CH7	CH8					
158 (9EH)								Mode switching setting (L)	0	Setting	×	○
159 (9FH)								Mode switching setting (H)		Setting	×	○
160 to 199 (A0H to C7H)								System area	—	—	—	—

*1 Item enabled by turning on and off 'Operating condition setting request' (Y9)

*2 For the R60DA4 or R60DAI8

*3 For the R60DAV8

■Offset/gain setting (For R60DA4) (Un\G200 to Un\G399)

Address Decimal (hexadecimal)				Name	Default value	Data type	Auto refresh	Enabled by Y9*1
CH1	CH2	CH3	CH4					
200 (C8H)				Save data type setting	0000H	Setting	×	○
201 (C9H)				System area	—	—	—	—
202 (CAH)	204 (CCH)	206 (CEH)	208 (D0H)	CH□ Factory default offset value	0	Setting	×	—
203 (CBH)	205 (CDH)	207 (CFH)	209 (D1H)	CH□ Factory default gain value	0	Setting	×	—
210 (D2H)	212 (D4H)	214 (D6H)	216 (D8H)	CH□ User range setting offset value	0	Setting	×	—
211 (D3H)	213 (D5H)	215 (D7H)	217 (D9H)	CH□ User range setting gain value	0	Setting	×	—
218 to 399 (DAH to 18FH)				System area	—	—	—	—

*1 Item enabled by turning on and off 'Operating condition setting request' (Y9)

■Offset/gain setting (For R60DAV8 and R60DAI8) (Un\G200 to Un\G399)

Address Decimal (hexadecimal)								Name	Default value	Data type	Auto refresh	Enabled by Y9*1
CH1	CH2	CH3	CH4	CH5	CH6	CH7	CH8					
200, 201 (C8H, C9H)								System area	—	—	—	—
202 (CAH)	204 (CCH)	206 (CEH)	208 (D0H)	210 (D2H)	212 (D4H)	214 (D6H)	216 (D8H)	CH□ Factory default offset value	0	Setting	×	—
203 (CBH)	205 (CDH)	207 (CFH)	209 (D1H)	211 (D3H)	213 (D5H)	215 (D7H)	217 (D9H)	CH□ Factory default gain value	0	Setting	×	—
218 (DAH)	220 (DCH)	222 (DEH)	224 (E0H)	226 (E2H)	228 (E4H)	230 (E6H)	232 (E8H)	CH□ User range setting offset value	0	Setting	×	—
219 (DBH)	221 (DDH)	223 (DFH)	225 (E1H)	227 (E3H)	229 (E5H)	231 (E7H)	233 (E9H)	CH□ User range setting gain value	0	Setting	×	—
234 to 399 (EAH to 18FH)								System area	—	—	—	—

*1 Item enabled by turning on and off 'Operating condition setting request' (Y9)

A

■Un\G401 to Un\G3749

Address Decimal (hexadecimal)								Name	Default value	Data type	Auto refresh	Enabled by Y9*1
CH1	CH2	CH3	CH4	CH5	CH6	CH7	CH8					
401 (191H)								System area	—	—	—	—
402 (192H)				403 (193H)				Range setting (CH1 to CH4) Range setting (CH5 to CH8)	0000H	Setting	×	○
404 to 999 (194H to 3E7H)								System area	—	—	—	—
1000 (3E8H)	1001 (3E9H)	1002 (3EAH)	1003 (3EBH)	1004 (3ECH)	1005 (3EDH)	1006 (3EEH)	1007 (3EFH)	CH□ Wave output start/stop request	0	Control	×	—
1008 (3F0H)	1009 (3F1H)	1010 (3F2H)	1011 (3F3H)	1012 (3F4H)	1013 (3F5H)	1014 (3F6H)	1015 (3F7H)	CH□ Output setting during wave output stop	1	Control	×	○
1016 (3F8H)	1017 (3F9H)	1018 (3FAH)	1019 (3FBH)	1020 (3FCH)	1021 (3FDH)	1022 (3FEH)	1023 (3FFH)	CH□ Output value during wave output stop	0	Control	×	○
1024 (400H)	1026 (402H)	1028 (404H)	1030 (406H)	1032 (408H)	1034 (40AH)	1036 (40CH)	1038 (40EH)	CH□ Wave pattern start address setting (Dword)	10000	Control	×	○
1040 (410H)	1042 (412H)	1044 (414H)	1046 (416H)	1048 (418H)	1050 (41AH)	1052 (41CH)	1054 (41EH)	CH□ Wave pattern data points setting (Dword)	0	Control	×	○
1056 (420H)	1057 (421H)	1058 (422H)	1059 (423H)	1060 (424H)	1061 (425H)	1062 (426H)	1063 (427H)	CH□ Wave pattern output repetition setting	1	Control	×	○
1064 (428H)	1065 (429H)	1066 (42AH)	1067 (42BH)	1068 (42CH)	1069 (42DH)	1070 (42EH)	1071 (42FH)	CH□ Constant for wave output conversion cycle	1	Control	×	○
1072 (430H)								Step action wave output request	0	Control	×	—
1073 to 1079 (431H to 437H)								System area	—	—	—	—
1080 (438H)	1081 (439H)	1082 (43AH)	1083 (43BH)	1084 (43CH)	1085 (43DH)	1086 (43EH)	1087 (43FH)	CH□ Wave output step action movement amount	0	Control	×	—
1088 to 1099 (440H to 44BH)								System area	—	—	—	—
1100 (44CH)	1101 (44DH)	1102 (44EH)	1103 (44FH)	1104 (450H)	1105 (451H)	1106 (452H)	1107 (453H)	CH□ Wave output status monitor	0	Monitor	○	—
1108 (454H)	1110 (456H)	1112 (458H)	1114 (45AH)	1116 (45CH)	1118 (45EH)	1120 (460H)	1122 (462H)	CH□ Wave output conversion cycle monitor (Dword)	0	Monitor	×	—
1124 (464H)	1125 (465H)	1126 (466H)	1127 (467H)	1128 (468H)	1129 (469H)	1130 (46AH)	1131 (46BH)	CH□ Wave pattern output count monitor	0	Monitor	×	—
1132 (46CH)	1134 (46EH)	1136 (470H)	1138 (472H)	1140 (474H)	1142 (476H)	1144 (478H)	1146 (47AH)	CH□ Wave output current address monitor (Dword)	0	Monitor	×	—
1148 (47CH)	1149 (47DH)	1150 (47EH)	1151 (47FH)	1152 (480H)	1153 (481H)	1154 (482H)	1155 (483H)	CH□ Wave output current digital value monitor	0	Monitor	×	—
1156 (484H)	1158 (486H)	1160 (488H)	1162 (48AH)	1164 (48CH)	1166 (48EH)	1168 (490H)	1170 (492H)	CH□ Wave output digital value outside the range Address monitor (Dword)	0	Monitor	×	—
1172 (494H)	1174 (496H)	1176 (498H)	1178 (49AH)	1180 (49CH)	1182 (49EH)	1184 (4A0H)	1186 (4A2H)	CH□ Wave output warning Address monitor (Dword)	0	Monitor	×	—
1188 to 1799 (4A4H to 707H)								System area	—	—	—	—
1800 (708H)								Latest address of error history	0	Monitor	○	—
1801 to 1809 (709H to 711H)								System area	—	—	—	—

Address Decimal (hexadecimal)								Name	Default value	Data type	Auto refresh	Enabled by Y9 ^{*1}
CH1	CH2	CH3	CH4	CH5	CH6	CH7	CH8					
1810 to 1969 (712H to 7B1H)								Error history No.1 to 16	0	Monitor	×	—
1970 to 1999 (7B2H to 7CFH)								System area	—	—	—	—
2000 (7D0H)	2002 (7D2H)	2004 (7D4H)	2006 (7D6H)	2008 (7D8H)	2010 (7DAH)	2012 (7DCH)	2014 (7DEH)	CH□ Synchronization digital value	0	Control	○	—
2015 to 2031 (7DFH to 7EFH)								System area	—	—	—	—
2032 (7F0H)								Output setting during synchronous Error	0	Setting	×	○
2033 to 2099 (7F1H to 833H)								System area	—	—	—	—
2100 (834H)								Synchronization status monitor	0	Monitor	○	—
2101 to 3749 (835H to EA5H)								System area	—	—	—	—

*1 Item enabled by turning on and off 'Operating condition setting request' (Y9)

■Un\G3750 to Un\G89999

Address (decimal)	Address (hexadecimal)	Name	Default value	Data type	Auto refresh	Enabled by Y9 ^{*1}
3750	EA6H	Latest alarm code	0	Monitor	○	—
3751	EA7H	Latest address of alarm history	0	Monitor	○	—
3752 to 3759	EA8H to EAFH	System area	—	—	—	—
3760 to 3919	EB0H to F4FH	Alarm history No.1 to 16	0	Monitor	×	—
3920 to 3999	F50H to F9FH	System area	—	—	—	—
4000 to 4015	FA0H to FAFH	Interrupt factor detection flag [n] ^{*2}	0	Monitor	○	—
4016 to 4031	FB0H to FBFH	System area	—	—	—	—
4032 to 4047	FC0H to FCFH	Interrupt factor mask [n] ^{*2}	0	Control	×	—
4048 to 4063	FD0H to FDFH	System area	—	—	—	—
4064 to 4079	FE0H to FEFH	Interrupt factor reset request [n] ^{*2}	0	Control	×	—
4080 to 4095	FF0H to FFFH	System area	—	—	—	—
4096 to 4111	1000H to 100FH	Interrupt factor generation setting [n] ^{*2}	0	Setting	×	○
4112 to 4127	1010H to 101FH	System area	—	—	—	—
4128 to 4143	1020H to 102FH	Condition target setting [n] ^{*2}	0	Setting	×	○
4144 to 4159	1030H to 103FH	System area	—	—	—	—
4160 to 4175	1040H to 104FH	Condition target channel setting [n] ^{*2}	0	Setting	×	○
4176 to 9999	1050H to 270FH	System area	—	—	—	—
10000 to 89999	2710H to 15F8FH	Wave data registry area	0	Setting	×	—

*1 Item enabled by turning on and off 'Operating condition setting request' (Y9)

*2 [n] in the table indicates an interrupt setting number. (n = 1 to 16)

Details of buffer memory addresses

The following describes the details of the buffer memory addresses of the D/A converter module.



This section describes buffer memory addresses for CH1.

Latest error code

The latest error code detected in the D/A converter module is stored. For details, refer to the following.

Page 106 Error Code List

■Buffer memory address

The following shows the buffer memory address of this area.

Buffer memory name	CH1	CH2	CH3	CH4	CH5	CH6	CH7	CH8
Latest error code	0							
Latest error code (When the Q compatible mode function is used)	19							

■Clearing an error

Turn on and off 'Error clear request' (YF).

Latest address of error history

Among 'Error history No.□' (Un\G3600 to Un\G3759), a buffer memory address which stores the latest error code is stored.

■Buffer memory address

The following shows the buffer memory address of this area.

Buffer memory name	CH1	CH2	CH3	CH4	CH5	CH6	CH7	CH8
Latest address of error history	1							
Latest address of error history (When the Q compatible mode function is used)	1800							

Latest alarm code

The latest alarm code detected in the D/A converter module is stored. For details, refer to the following.

Page 110 Alarm Code List

■Buffer memory address

The following shows the buffer memory address of this area.

Buffer memory name	CH1	CH2	CH3	CH4	CH5	CH6	CH7	CH8
Latest alarm code	2							
Latest alarm code (When the Q compatible mode function is used)	3750							

■Clearing an alarm

Turn on and off 'Alert output clear request' (YE) or 'Operating condition setting request' (Y9).

Latest address of alarm history

Among 'Alarm history No.□' (Un\G3760 to Un\G3999), a buffer memory address which stores the latest alarm code is stored.

■Buffer memory address

The following shows the buffer memory address of this area.

Buffer memory name	CH1	CH2	CH3	CH4	CH5	CH6	CH7	CH8
Latest address of alarm history	3							
Latest address of alarm history (When the Q compatible mode function is used)	3751							

Interrupt factor detection flag [n]

The detection status of the interrupt factor is stored.

Monitor value	Description
0	No interrupt factor
1	Interrupt factor

When an interrupt factor occurs, an interrupt request is sent to the CPU module at the same time as 'Interrupt factor detection flag [n]' (Un\G4 to Un\G19) is turned to Interrupt factor (1).

"n" indicates an interrupt setting number. (n = 1 to 16)

■Buffer memory address

The following shows the buffer memory address of this area.

Buffer memory name	1	2	3	4	5	6	7	8	9	10	11	12	13	14	15	16
Interrupt factor detection flag [n]	4	5	6	7	8	9	10	11	12	13	14	15	16	17	18	19
Interrupt factor detection flag [n] (When the Q compatible mode function is used)	4000	4001	4002	4003	4004	4005	4006	4007	4008	4009	4010	4011	4012	4013	4014	4015

Alert output upper limit flag

The upper limit alarm can be checked for each channel.

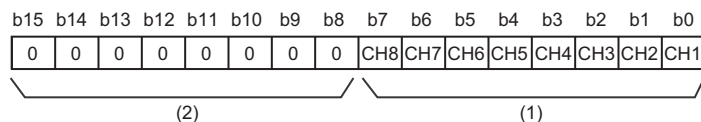

(1) 0: Normal, 1: Alert alarm ON

(2) b4 to b15 of the R60DA4 and b8 to b15 of the R60DAV8 and R60DAI8 are fixed to 0.

■Buffer memory address

The following shows the buffer memory address of this area.

Buffer memory name	CH1	CH2	CH3	CH4	CH5	CH6	CH7	CH8
Alert output upper limit flag	36							

■Alert output upper limit flag status

- When the value is out of the range specified in the alert output upper limit value, Alert alarm ON (1) is stored in 'Alert output upper limit flag' (Un\G36) corresponding to each channel.
- When an alert is detected in any channel where the D/A conversion and the alert output setting are enabled, 'Alert output signal' (XE) also turns on.

■Clearing Alert output upper limit flag

Turn on and off 'Operating condition setting request' (Y9) or 'Alert output clear request' (YE).

Alert output lower limit flag

The lower limit alarm can be checked for each channel.

b15	b14	b13	b12	b11	b10	b9	b8	b7	b6	b5	b4	b3	b2	b1	b0
0	0	0	0	0	0	0	0	CH8	CH7	CH6	CH5	CH4	CH3	CH2	CH1
(2)								(1)							

(1) 0: Normal, 1: Alert alarm ON

(2) b4 to b15 of the R60DA4 and b8 to b15 of the R60DAV8 and R60DAI8 are fixed to 0.

■Buffer memory address

The following shows the buffer memory address of this area.

Buffer memory name	CH1	CH2	CH3	CH4	CH5	CH6	CH7	CH8
Alert output lower limit flag	37							

■Alert output upper limit flag status

- When the value is out of the range specified in the alert output lower limit value, Alert alarm ON (1) is stored in 'Alert output lower limit flag' (Un\G37) corresponding to each channel.
- When an alert is detected in any channel where the D/A conversion and the alert output setting are enabled, 'Alert output signal' (XE) also turns on.

■Clearing Alert output lower limit flag

Turn on and off 'Operating condition setting request' (Y9) or 'Alert output clear request' (YE).

Alert output flag [Q compatible mode]

When the Q compatible mode function is used, the upper/lower limit alert can be checked.

b15	b14	b13	b12	b11	b10	b9	b8	b7	b6	b5	b4	b3	b2	b1	b0
CH8	CH8	CH7	CH7	CH6	CH6	CH5	CH5	CH4	CH4	CH3	CH3	CH2	CH2	CH1	CH1
Lower limit value	Upper limit value	Lower limit value	Upper limit value	Lower limit value	Upper limit value	Lower limit value	Upper limit value	Lower limit value	Upper limit value	Lower limit value	Upper limit value	Lower limit value	Upper limit value	Lower limit value	Upper limit value
(2)								(1)							

(1) 0: Normal, 1: Alarm ON

(2) b8 to b15 of the R60DA4 are fixed to 0.

■Buffer memory address

The following shows the buffer memory address of this area.

Buffer memory name	CH1	CH2	CH3	CH4	CH5	CH6	CH7	CH8
Alert output flag	48							

■Alert output flag status

- When the value is out of the range specified in the alert output upper limit value or alert output lower limit value, Alert alarm ON (1) is stored in 'Alert output flag' (Un\G48) corresponding to each channel.
- When an alert is detected in any channel where the D/A conversion and the alert output setting are enabled, 'Alert output signal' (XE) also turns on.

■Clearing Alert output flag

Turn on and off 'Operating condition setting request' (Y9) or 'Alert output clear request' (YE).

Disconnection detection flag

By setting 4 to 20mA for the analog output range and enabling the D/A conversion, a disconnection can be detected for each channel.

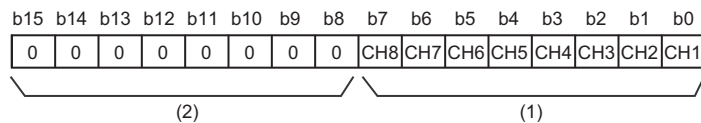

(1) 0: Normal, 1: Disconnection detection

(2) b4 to b15 of the R60DA4 and b8 to b15 of the R60DAV8 and R60DAI8 are fixed to 0.

■ Buffer memory address

The following shows the buffer memory address of this area.

Buffer memory name	CH1	CH2	CH3	CH4	CH5	CH6	CH7	CH8
Disconnection detection flag	38							
Disconnection detection flag (When the Q compatible mode function is used)	49							

■ Disconnection detection flag status

- When a disconnection is detected, Disconnection detection (1) is stored in 'Disconnection detection flag' (Un\G38) corresponding to each channel.
- When a disconnection is detected in any channel, 'Disconnection detection signal' (XD) turns on.

■ Clearing Disconnection detection flag

Even if the disconnection cause is eliminated, the analog output does not restart automatically to prevent an incorrect output. To restart the analog output, check CH□ Digital value and turn on and off 'Error clear request' (YF). According to the status of CH□ Output enable/disable (Y1 to Y8), the analog output restarts.

When the analog output restarts, the disconnection detection flag of the corresponding channel is cleared.

Output mode

In the normal mode, the set output mode can be checked.

Monitor value	Description
0H	Normal output mode
1H	Wave output mode

■ Buffer memory address

The following shows the buffer memory address of this area.

Buffer memory name	CH1	CH2	CH3	CH4	CH5	CH6	CH7	CH8
Output mode	60							
Output mode (When the Q compatible mode function is used)	9							

Interrupt factor mask [n]

Set Interrupt factor mask to be used.

Setting value	Setting content
0	Mask (Interrupt unused)
1	Mask clear (Interrupt used)

When 'Interrupt factor mask [n]' (Un\G124 to Un\G139) is set to Mask clear (Interrupt used) (1) and an interrupt factor occurs, an interrupt request is sent to the CPU module. When the set value is two or larger, the setting is regarded as Mask clear (Interrupt used) (1).

"n" indicates an interrupt setting number. (n = 1 to 16)

■Buffer memory address

The following shows the buffer memory address of this area.

Buffer memory name	1	2	3	4	5	6	7	8	9	10	11	12	13	14	15	16
Interrupt factor mask [n]	124	125	126	127	128	129	130	131	132	133	134	135	136	137	13	139
Interrupt factor mask [n] (When the Q compatible mode function is used)	4032	4033	4034	4035	4036	4037	4038	4039	4040	4041	4042	4043	4044	4045	4046	4047

■Default value

The default value is set to Mask (Interrupt unused) (0) for all channels.

Interrupt factor reset request [n]

An interrupt factor reset request is sent.

Setting value	Setting content
0	No reset request
1	Reset request

When Reset request (1) is set to 'Interrupt factor reset request [n]' (Un\G156 to Un\G171) corresponding to the interrupt factor, the interrupt factor corresponding to the specified interrupt is reset. After that, 'Interrupt factor reset request [n]' (Un\G156 to Un\G171) turns to No reset request (0). When the set value is two or larger, the setting is regarded as Reset request (1).

Interrupt factors can also be reset by turning on and off 'Operating condition setting request' (Y9).

"n" indicates an interrupt setting number. (n = 1 to 16)

■Buffer memory address

The following shows the buffer memory address of this area.

Buffer memory name	1	2	3	4	5	6	7	8	9	10	11	12	13	14	15	16
Interrupt factor reset request [n]	156	157	158	159	160	161	162	163	164	165	166	167	168	169	170	171
Interrupt factor reset request [n] (When the Q compatible mode function is used)	4064	4065	4066	4067	4068	4069	4070	4071	4072	4073	4074	4075	4076	4077	4078	4079

■Default value

The default value is No reset request (0) for all buffer memory areas.

Step action wave output request

Set whether to execute the step action wave output for all the analog output channels in a batch.

Step action wave output request	Setting value
OFF	0
ON	1

The setting for this area is enabled only in the wave output mode. In other modes, changing the setting value is ignored. When the setting value is changed from OFF (0) to ON (1), the wave output status in all the channels, where the D/A conversion is enabled, is changed to During wave output step action and the wave output step action function is enabled. When the setting value is changed from ON (1) to OFF (0), the wave output status is changed to During wave output stop and the wave output step action ends.

When a value out of the setting range is set, a step action wave output request range error (error code: 1D80H) occurs and the wave output status is not changed.

■Buffer memory address

The following shows the buffer memory address of this area.

Buffer memory name	CH1	CH2	CH3	CH4	CH5	CH6	CH7	CH8
Step action wave output request	188							
Step action wave output request (When the Q compatible mode function is used)	1072							

■Default value

The default value is OFF (0).

Interrupt factor generation setting [n]

Set an interrupt request for when the same interrupt factor occurs during the interrupt factor detection.

Setting value	Setting content
0	Interrupt resend request
1	No interrupt resend request

- When 'Interrupt factor generation setting [n]' (Un\G200 to Un\G215) is Interrupt resend request (0) and the same interrupt factor occurs during the interrupt factor detection, an interrupt request is sent to the CPU module again.
- When 'Interrupt factor generation setting [n]' (Un\G200 to Un\G215) is No interrupt resend request (1) and the same interrupt factor occurs during the interrupt factor detection, an interrupt request is not sent to the CPU module.

If a value other than the above is set, an interrupt factor generation setting range error (error code: 180△H) occurs.

"n" and △ indicate an interrupt setting number. (n = 1 to 16, △ = 0 to F)

■Buffer memory address

The following shows the buffer memory address of this area.

Buffer memory name	1	2	3	4	5	6	7	8	9	10	11	12	13	14	15	16
Interrupt factor generation setting [n]	200	201	202	203	204	205	206	207	208	209	210	211	212	213	214	215
Interrupt factor generation setting [n] (When the Q compatible mode function is used)	4096	4097	4098	4099	4100	4101	4102	4103	4104	4105	4106	4107	4108	4109	4110	4111

■Enabling the setting

Turn on and off 'Operating condition setting request' (Y9) to enable the setting.

■Default value

The default value is Interrupt resend request (0) for all buffer memory areas.

Condition target setting [n]

Set an interrupt factor to be detected.

Setting value	Setting content
0	Disable
1	Error flag (XF)
2	Alert output flag
3	Disconnection detection flag
4	External power supply READY flag (X7)

If a value other than the above is set, a condition target setting range error (error code: 181 Δ H) occurs.

Turning off and on 'Error flag' (XF) or the buffer memory areas set in 'Condition target setting [n]' (Un\G232 to Un\G247) or turning on and off 'External power supply READY flag' (X7) set in 'Condition target setting [n]' (Un\G232 to Un\G247) send an interrupt request for the CPU module.

"n" and Δ indicate an interrupt setting number. (n = 1 to 16, Δ = 0 to F)

■Buffer memory address

The following shows the buffer memory address of this area.

Buffer memory name	1	2	3	4	5	6	7	8	9	10	11	12	13	14	15	16
Condition target setting [n]	232	233	234	235	236	237	238	239	240	241	242	243	244	245	246	247
Condition target setting [n] (When the Q compatible mode function is used)	4128	4129	4130	4131	4132	4133	4134	4135	4136	4137	4138	4139	4140	4141	4142	4143

■Enabling the setting

Turn on and off 'Operating condition setting request' (Y9) to enable the setting.

■Default value

The default value is Disable (0) for all buffer memory areas.

Condition target channel setting [n]

Set a channel where an interrupt is detected.

Setting value	Setting content
0	All CH specification
1	CH1
2	CH2
3	CH3
4	CH4
5	CH5
6	CH6
7	CH7
8	CH8

When a factor for the channel specification is set to 'Condition target setting [n]' (Un\G232 to Un\G247), an interrupt factor in the channel set by this area is monitored. When a factor of the input signal (X) is set, the setting in this area is ignored. If a value other than the above is set, a condition target setting range error (error code: 182△H) occurs.

"n" and △ indicate an interrupt setting number. (n = 1 to 16, △ = 0 to F)

■Buffer memory address

The following shows the buffer memory address of this area.

Buffer memory name	1	2	3	4	5	6	7	8	9	10	11	12	13	14	15	16
Condition target channel setting [n]	264	265	266	267	268	269	270	271	272	273	274	275	276	277	278	279
Condition target channel setting [n] (When the Q compatible mode function is used)	4160	4161	4162	4163	4164	4165	4166	4167	4168	4169	4170	4171	4172	4173	4174	4175

■Setting range

For R60DA4, the setting range is from 0 to 4.

■Enabling the setting

Turn on and off 'Operating condition setting request' (Y9) to enable the setting.

■Default value

The default value is All CH specification (0) for all buffer memory areas.

Mode switching setting

Set a setting value for the mode to be switched.

Switching mode	Setting value	
	296	297
Normal mode	5260H	4441H
Offset/gain setting mode	4441H	5260H

When a value other than the above is set, the mode switching is not executed and only the operating condition is changed.

■Buffer memory address

The following shows the buffer memory address of this area.

Buffer memory name	CH1	CH2	CH3	CH4	CH5	CH6	CH7	CH8
Mode switching setting	296, 297							
Mode switching setting (When the Q compatible mode function is used)	158, 159							

■Enabling the setting

Turn on 'Operating condition setting request' (Y9).

■After the mode is switched

When the mode is switched, this area is cleared to 0 and 'Operating condition setting completed flag' (X9) turns off.

After checking that 'Operating condition setting completed flag' (X9) is off, turn off 'Operating condition setting request' (Y9).

CH1 Set value check code

The check result of whether the set digital value is within the setting range can be checked.

The target values are 'CH1 Digital value' (Un\G460) in the normal output and the wave data to be output in the wave output. When a digital value out of the setting range is written, one of the following check codes is stored.

Check code	Description
000FH	A digital value exceeding the setting range has been written.
00F0H	A digital value falling short of the setting range has been written.
00FFH	A digital value falling short of the setting range and a digital value exceeding the setting range have been written. This check code may be stored when a check code is not reset.

Once the check code is stored, the code is not reset even when the digital value falls within the setting range.

To reset the check code, rewrite the digital value to a value within the setting range and turn on and off 'Error clear request' (YF).

When the scaling function is used, the value of 'CH1 Digital value' (Un\G460) which has undergone a scale conversion is checked. Note that some errors may be observed in the target digital value for a check code to be stored due to the calculation error of scale conversion when a scale-converted value exceeds the setting range.

When a check code is stored in the wave output, the address of the wave data which is out of the setting range can be checked with 'CH1 Wave output digital value outside the range Address monitor' (Un\G440 to Un\G441).

■Buffer memory address

The following shows the buffer memory address of this area.

Buffer memory name	CH1	CH2	CH3	CH4	CH5	CH6	CH7	CH8
CH□ Setting value check code	400	600	800	1000	1200	1400	1600	1800
CH□ Setting value check code (When the Q compatible mode function is used)	11	12	13	14	15	16	17	18

CH1 Wave output status monitor

The wave output status can be checked.

Monitor value	Description
0H	During wave output stop
1H	During wave output
2H	Wave output pause
3H	During wave output step action

Only when the wave output function is used and the operation mode is normal mode, a value is stored in the area. Otherwise, 0 is stored.

■Buffer memory address

The following shows the buffer memory address of this area.

Buffer memory name	CH1	CH2	CH3	CH4	CH5	CH6	CH7	CH8
CH□ Wave output status monitor	401	601	801	1001	1201	1401	1601	1801
CH□ Wave output status monitor (When the Q compatible mode function is used)	1100	1101	1102	1103	1104	1105	1106	1107

CH1 Range setting monitor

The output range value set to 'CH1 Range setting' (Un\G598) can be checked.

Monitor value	Description
0H	4 to 20mA
1H	0 to 20mA
2H	1 to 5V
3H	0 to 5V
4H	-10 to 10V
EH	User range setting (voltage)
FH	User range setting (current)

■Buffer memory address

The following shows the buffer memory address of this area.

Buffer memory name	CH1	CH2	CH3	CH4	CH5	CH6	CH7	CH8
CH□ Range setting monitor	430	630	830	1030	1230	1430	1630	1830



Because the output range cannot be changed for channels set to D/A conversion disabled, the stored value in this area is not updated. For details, refer to the following.

☞ Page 18 Range Switching Function

Range setting monitor [Q compatible mode]

When the Q compatible mode function is used, the output range value set in the output range setting can be checked.

The following shows the setting details in the Q compatible mode.

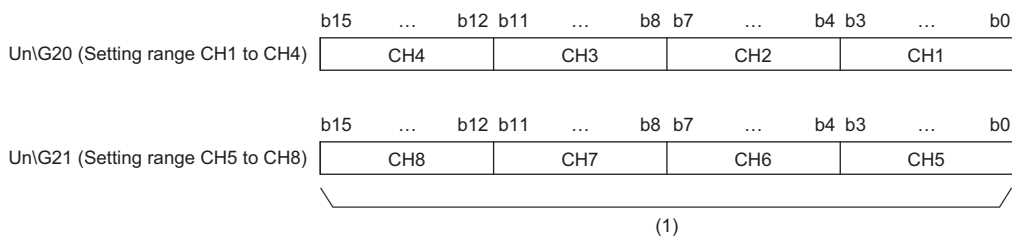

(1) The buffer memory address 21 of R60DA4 is fixed to 0.

Monitor value	Description
0H	4 to 20mA
1H	0 to 20mA
2H	1 to 5V
3H	0 to 5V
4H	-10 to 10V
EH	User range setting (voltage)
FH	User range setting (current)

■Buffer memory address

The following shows the buffer memory address of this area.

Buffer memory name	CH1	CH2	CH3	CH4	CH5	CH6	CH7	CH8
Range setting monitor	20				21			



Because the output range cannot be changed for channels set to D/A conversion disabled, the bit corresponding to the relevant channel in this area is not updated. For details, refer to the following.

☞ Page 18 Range Switching Function

CH1 HOLD/CLEAR function setting monitor

The setting status of the HOLD/CLEAR function can be checked.

Monitor value	Description
0	CLEAR
1	HOLD

■Buffer memory address

The following shows the buffer memory address of this area.

Buffer memory name	CH1	CH2	CH3	CH4	CH5	CH6	CH7	CH8
CH□ HOLD/CLEAR function setting monitor	431	631	831	1031	1231	1431	1631	1831

HOLD/CLEAR function setting monitor [Q compatible mode]

When the Q compatible mode function is used, the setting status of the HOLD/CLEAR function can be checked.

The following shows the setting details in the Q compatible mode.

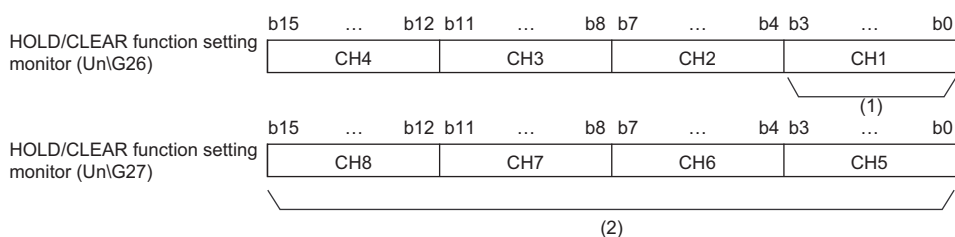

(1) 0: CLEAR, 1 to F: HOLD

(2) The buffer memory address 27 of R60DA4 is fixed to 0.

■Buffer memory address

The following shows the buffer memory address of this area.

Buffer memory name	CH1	CH2	CH3	CH4	CH5	CH6	CH7	CH8
HOLD/CLEAR function setting monitor	26				27			

CH1 Wave output conversion cycle monitor

The wave output conversion cycle can be checked with values in 32-bit signed binary.

Only when the wave output function is used and the operation mode is normal mode, a value is stored in the area. Otherwise, 0 is stored.

The unit of the stored value is μs .

When 'Operating condition setting request' (Y9) is turned on and off, the monitored value is updated.

■Buffer memory address

The following shows the buffer memory address of this area.

Buffer memory name	CH1	CH2	CH3	CH4	CH5	CH6	CH7	CH8
CH□ Wave output conversion cycle monitor	432 433	632 633	832 833	1032 1033	1232 1233	1432 1433	1632 1633	1832 1833
CH□ Wave output conversion cycle monitor (When the Q compatible mode function is used)	1108	1110	1112	1114	1116	1118	1120	1122

CH1 Wave pattern output count monitor

The output count of the wave pattern can be checked.

Only when the wave output function is used and the operation mode is normal mode, a value is stored in the area. Otherwise, 0 is stored.

The stored value increases by one every time one cycle of a wave pattern is output. The measuring range is from 0 to 32767. When the wave pattern output repetition setting is set to Unlimitedly repeat output, the count returns to 0 and starts again from 1 after the 32767th count. (...32766 → 32767 → 0 → 1 → 2 ...)

In the following cases, the stored value is reset.

- When 'Operating condition setting request' (Y9) is turned on and off
- When the wave output status transitions from During wave output stop to another wave output status

■Buffer memory address

The following shows the buffer memory address of this area.

Buffer memory name	CH1	CH2	CH3	CH4	CH5	CH6	CH7	CH8
CH□ Wave pattern output count monitor	434	634	834	1034	1234	1434	1634	1834
CH□ Wave pattern output count monitor (When the Q compatible mode function is used)	1124	1125	1126	1127	1128	1129	1130	1131

CH1 Wave output current address monitor

In the wave output mode, which data in the wave data registry area is D/A-converted and output can be checked.

Only in the wave output mode, the buffer memory address of the wave output data is stored in this area.

■Buffer memory address

The following shows the buffer memory address of this area.

Buffer memory name	CH1	CH2	CH3	CH4	CH5	CH6	CH7	CH8
CH□ Wave output current address monitor	436 437	636 637	836 837	1036 1037	1236 1237	1436 1437	1636 1637	1836 1837
CH□ Wave output current address monitor (When the Q compatible mode function is used)	1132	1134	1136	1138	1140	1142	1144	1146

CH1 Wave output current digital value monitor

The digital value of the current output wave can be checked.

Only in the wave output mode, a value is stored in this area. The stored value differs depending on the wave output status. Otherwise, 0 is stored.

The following shows the correspondence relation between the wave output status and the stored value.

- During wave output stop

Output digital value selected in 'CH1 Output setting during wave output stop' (Un\G524)

Setting value of Output setting during wave output stop	Stored value
0V/0mA (0)	0
Offset value (1)	
Setting value during stop (2)	Setting value of 'CH1 Output value during wave output stop' (Un\G525)

- During wave output

Digital value stored in the buffer memory address indicated with 'CH1 Wave output current address monitor' (Un\G436 to Un\G437)

- Wave output pause

The value differs depending on the analog output HOLD/CLEAR setting.

Setting of analog output HOLD/CLEAR function	Stored value
HOLD setting	Digital value stored in the buffer memory address indicated with this area
CLEAR setting	0

- During wave output step action

Digital value stored in the buffer memory address indicated with 'CH1 Wave output current address monitor' (Un\G436 to Un\G437)

When 'Operating condition setting request' (Y9) is turned on and off, the stored value is reset.

The stored value of when the D/A conversion and output are enabled is shown. For the analog output in other statuses, refer to the following.

☞ Page 20 In the wave output mode

■Buffer memory address

The following shows the buffer memory address of this area.

Buffer memory name	CH1	CH2	CH3	CH4	CH5	CH6	CH7	CH8
CH□ Wave output current digital value monitor	438	638	838	1038	1238	1438	1638	1838
CH□ Wave output current digital value monitor (When the Q compatible mode function is used)	1148	1149	1150	1151	1152	1153	1154	1155

CH1 Wave output digital value out-of-range address monitor

When the digital value of the output wave data is out of the range, the buffer memory address of the wave data with a value out of the range can be checked.

Only in the wave output mode, a value is stored in this area. Otherwise, 0 is stored.

When the multiple wave data with a digital input value out of the setting range are detected, only the buffer memory address of the wave data detected first is stored.

When the first detection of a digital value out of the range occurs in a wave output status other than During wave output stop, the stored value is updated.

To reset this area, correct the wave data to a value within the available setting range. After that, turn on and off 'Error clear request' (YF) or 'Operating condition setting request' (Y9) to reset this area.

■Buffer memory address

The following shows the buffer memory address of this area.

Buffer memory name	CH1	CH2	CH3	CH4	CH5	CH6	CH7	CH8
CH□ Wave output digital value out-of-range address monitor	440	640	840	1040	1240	1440	1640	1840
	441	641	841	1041	1241	1441	1641	1841
CH□ Wave output digital value out-of-range address monitor (When the Q compatible mode function is used)	1156	1158	1160	1162	1164	1166	1168	1170

CH1 Wave output warning address monitor

The buffer memory address of the wave data where a warning has occurred can be checked.

Only in the wave output mode, a value is stored in this area. Otherwise, 0 is stored.

When a warning has occurred in the multiple wave data, only the buffer memory address of the wave data where the warning occurred first is stored.

When the first warning occurs in a wave output status other than During wave output stop, the stored value is updated.

To reset this area, correct the wave data to a value within the setting range. After that, turn on and off 'Alert output clear request' (YE) or 'Operating condition setting request' (Y9) to reset this area.

■Buffer memory address

The following shows the buffer memory address of this area.

Buffer memory name	CH1	CH2	CH3	CH4	CH5	CH6	CH7	CH8
CH□ Wave output warning address monitor	442	642	842	1042	1242	1442	1642	1842
	443	643	843	1043	1243	1443	1643	1843
CH□ Wave output warning address monitor (When the Q compatible mode function is used)	1172	1174	1176	1178	1180	1182	1184	1186

CH1 Digital value

Set the digital input value in 16-bit signed binary for the D/A conversion from the CPU module.

Output range setting	When the scaling function is disabled	When the scaling function is enabled*1
	Setting range (practical range)	Setting range
0: 4 to 20mA	-768 to 32767 (practical range: 0 to 32000)	-32000 to 32000
1: 0 to 20mA		
2: 1 to 5V		
3: 0 to 5V		
4: -10 to 10V	-32768 to 32767 (practical range: -32000 to 32000)	
E: User range setting (voltage)		
F: User range setting (current)		

*1 The available setting range and practical range of when the scaling function is enabled differ depending on the setting of the scaling upper limit value and scaling lower limit value.

When a value out of the available setting range is written, the D/A conversion is performed with the upper or lower limit value of the available setting range.

A check code is stored in 'CH1 Setting value check code' (Un\G400) and a digital value setting range error (error code: 191□H) is stored in 'Latest error code' (Un\G0).

When the wave output function is selected, this area is disabled because registered wave data is output.

■Buffer memory address

The following shows the buffer memory address of this area.

Buffer memory name	CH1	CH2	CH3	CH4	CH5	CH6	CH7	CH8
CH□ Digital value	460	660	860	1060	1260	1460	1660	1860
CH□ Digital value (When the Q compatible mode function is used)	1	2	3	4	5	6	7	8

CH1 Wave output start/stop request

This area is for requesting start or stop of wave output to the D/A converter module when the wave output function is used.

The setting for this area is enabled only in the wave output mode. In other modes, changing the setting value is ignored.

Request	Setting value
Wave output stop request	0
Wave output start request	1
Wave output pause request	2

While 'Step action wave output request' (Un\G188) is set to ON (1), changing the setting value is ignored.

When 'Step action wave output request' (Un\G188) is changed from ON (1) to OFF (0), the wave output status changes to OFF. During wave output stop and Wave output stop request (0) is set for this area.

In the channel where a value out of the setting range is set, a wave output start/stop setting range error (error code: 1D1□H) occurs and 'Error flag' (XF) turns on. The operation of the wave output before the change continues.

■Buffer memory address

The following shows the buffer memory address of this area.

Buffer memory name	CH1	CH2	CH3	CH4	CH5	CH6	CH7	CH8
CH□ Wave output start/stop request	462	662	862	1062	1262	1462	1662	1862
CH□ Wave output start/stop request (When the Q compatible mode function is used)	1000	1001	1002	1003	1004	1005	1006	1007

■Default value

The default value is Wave output stop request (0) for all channels.

CH1 Input value shift amount

The set value is added to the digital input value regardless of the on/off status of 'Operating condition setting request' (Y9). For the shift function, refer to the following.

☞ Page 26 Shift Function

■Buffer memory address

The following shows the buffer memory address of this area.

Buffer memory name	CH1	CH2	CH3	CH4	CH5	CH6	CH7	CH8
CH□ Input value shift amount	480	680	880	1080	1280	1480	1680	1880
CH□ Input value shift amount (When the Q compatible mode function is used)	150	151	152	153	154	155	156	157

■Setting range

The setting range is from -32768 to 32767.

■Default value

The default value is 0 for all channels.

CH1 Wave output step action movement amount

This area is for setting the wave output step action movement amount and for checking if the target has been obtained.

The value set in this area is subtracted from or added to the buffer memory address that has been storing the value and so the buffer memory address of Wave data registry area that has been storing the target digital value is specified. When a value is set in this area, the target address starts to be specified and when specifying the address is complete, No movement (0) is stored.

The setting for this area is enabled only when the following conditions are satisfied.

- In the wave output mode
- When During wave output step action (3) is stored in 'CH1 Wave output status monitor' (Un\G401).

Movement direction	Setting value
No movement	0
Forward movement (movement in the direction to increase the address)	1 to 30000
Reverse movement (movement in the direction to decrease the address)	-30000 to -1

The setting range is from -30000 to 30000. Even if a set value is out of the setting range, no error occurs. When a value smaller than -30000 is set, the value is processed as -30000. When a value greater than 30000 is set, the value is processed as 30000.

The following shows the available range for movement.

- "Wave pattern start address" to "Wave pattern start address" + "Wave pattern data points setting" - 1

If a value equal to or more than the wave pattern data points is set, only the data for the wave pattern data points is processed.

Set a value for the wave output step action movement amount. When specifying the address is complete, No movement (0) is stored in this area.

■Buffer memory address

The following shows the buffer memory address of this area.

Buffer memory name	CH1	CH2	CH3	CH4	CH5	CH6	CH7	CH8
CH□ Wave output step action movement amount	482	682	882	1082	1282	1482	1682	1882
CH□ Wave output step action movement amount (When the Q compatible mode function is used)	1080	1081	1082	1083	1084	1085	1086	1087

■Default value

The default value is No movement (0) for all channels.

CH1 D/A conversion enable/disable setting

Set whether to enable or disable the D/A conversion.

For details on the D/A conversion enable/disable function, refer to the following.

☞ Page 19 D/A Conversion Enable/Disable Function

Setting value	Description
0	D/A conversion enable
1	D/A conversion disable

When a value other than the above is set, the value is processed as D/A conversion disable (1).

■Buffer memory address

The following shows the buffer memory address of this area.

Buffer memory name	CH1	CH2	CH3	CH4	CH5	CH6	CH7	CH8
CH0 D/A conversion enable/disable setting	500	700	900	1100	1300	1500	1700	1900

■Enabling the setting

Turn on and off 'Operating condition setting request' (Y9) to enable the setting.

■Default value

The default value is D/A conversion disable (1) for all channels.

D/A conversion enable/disable setting [Q compatible mode]

When the Q compatible mode function is used, set whether to enable or disable the D/A conversion.

The following shows the setting details in the Q compatible mode.

b15	b14	b13	b12	b11	b10	b9	b8	b7	b6	b5	b4	b3	b2	b1	b0
0	0	0	0	0	0	0	0	CH8	CH7	CH6	CH5	CH4	CH3	CH2	CH1
(2)								(1)							

(1) 0: D/A conversion enabled, 1: D/A conversion disabled

(2) b4 to b15 of the R60DA4 and b8 to b15 of the R60DAV8 and R60DAI8 are fixed to 0.

■Buffer memory address

The following shows the buffer memory address of this area.

Buffer memory name	CH1	CH2	CH3	CH4	CH5	CH6	CH7	CH8
D/A conversion enable/disable setting	0							

CH1 Scaling enable/disable setting

Set whether to enable or disable the scaling.

For the scaling function, refer to the following.

☞ Page 23 Scaling Function

Setting value	Description
0	Enable
1	Disable

If a value other than the above is set, a scaling enable/disable setting range error (error code: 1A0□H) occurs.

The scaling function cannot be used when the wave output function is used. In the channel for which Enable (0) is set while the wave output function is being used, a scaling setting error in wave output mode (alarm code: 0B0□H) occurs.

■Buffer memory address

The following shows the buffer memory address of this area.

Buffer memory name	CH1	CH2	CH3	CH4	CH5	CH6	CH7	CH8
CH□ Scaling enable/disable setting	502	702	902	1102	1302	1502	1702	1902

■Enabling the setting

Turn on and off 'Operating condition setting request' (Y9) to enable the setting.

■Default value

The default value is Disable (1) for all channels.

Scaling enable/disable setting [Q compatible mode]

When the Q compatible mode function is used, set whether to enable or disable the scaling.

The following shows the setting details in the Q compatible mode.

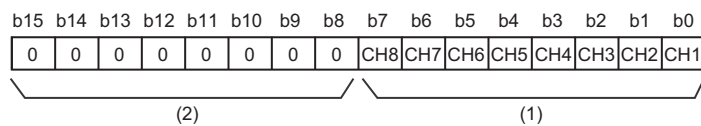

(1) 0: Scaling enabled, 1: Scaling disabled

(2) b4 to b15 of the R60DA4 and b8 to b15 of the R60DAV8 and R60DAI8 are fixed to 0.

■Buffer memory address

The following shows the buffer memory address of this area.

Buffer memory name	CH1	CH2	CH3	CH4	CH5	CH6	CH7	CH8
Scaling enable/disable setting	53							

CH1 Scaling upper limit value

Set the range of the scale conversion.

For the scaling function, refer to the following.

 Page 23 Scaling Function

■Buffer memory address

The following shows the buffer memory address of this area.

Buffer memory name	CH1	CH2	CH3	CH4	CH5	CH6	CH7	CH8
CH□ Scaling upper limit value	504	704	904	1104	1304	1504	1704	1904
CH□ Scaling upper limit value (When the Q compatible mode function is used)	55	57	59	61	63	65	67	69

■Setting range

The setting range is from -32000 to 32000. In the channel where a value out of the range is set, a scaling setting range error (error code: 1A1□H) occurs. In the channel where a set value does not satisfy the condition "scaling upper limit value ≠ scaling lower limit value", a scaling upper/lower limit value setting error (error code: 1A2□H) occurs.

When 'CH1 Scaling enable/disable setting' (Un\G502) is set to Disable (1), the setting for 'CH1 Scaling upper limit value' (Un\G504) is ignored.

■Enabling the setting

Turn on and off 'Operating condition setting request' (Y9) to enable the setting.

■Default value

The default value is 0 for all channels.

CH1 Scaling lower limit value

Set the range of the scale conversion.

For the scaling function, refer to the following.

 Page 23 Scaling Function

■Buffer memory address

The following shows the buffer memory address of this area.

Buffer memory name	CH1	CH2	CH3	CH4	CH5	CH6	CH7	CH8
CH□ Scaling lower limit value	506	706	906	1106	1306	1506	1706	1906
CH□ Scaling lower limit value (When the Q compatible mode function is used)	54	56	58	60	62	64	66	68

■Setting range

The setting range is from -32000 to 32000. In the channel where a value out of the range is set, a scaling setting range error (error code: 1A1□H) occurs. In the channel where a set value does not satisfy the condition "scaling upper limit value ≠ scaling lower limit value", a scaling upper/lower limit value setting error (error code: 1A2□H) occurs.

When 'CH1 Scaling enable/disable setting' (Un\G502) is set to Disable (1), the setting for 'CH1 Scaling lower limit value' (Un\G506) is ignored.

■Enabling the setting

Turn on and off 'Operating condition setting request' (Y9) to enable the setting.

■Default value

The default value is 0 for all channels.

CH1 Alert output setting

Set whether to enable or disable the alert output.

For the alert output function, refer to the following.

☞ Page 28 Alert Output Function

Setting value	Description
0	Enable
1	Disable

If a value other than the above is set, an alert output setting range error (error code: 1B0□H) occurs.

■Buffer memory address

The following shows the buffer memory address of this area.

Buffer memory name	CH1	CH2	CH3	CH4	CH5	CH6	CH7	CH8
CH□ Alert output setting	508	708	908	1108	1308	1508	1708	1908

■Enabling the setting

Turn on and off 'Operating condition setting request' (Y9) to enable the setting.

■Default value

The default value is Disable (1) for all channels.

Alert output setting [Q compatible mode]

When the Q compatible mode function is used, set whether to enable or disable the disconnection detection or alert output.

The following shows the setting details in the Q compatible mode.

b15	b14	b13	b12	b11	b10	b9	b8	b7	b6	b5	b4	b3	b2	b1	b0
0	0	0	0	0	0	0	0	CH8	CH7	CH6	CH5	CH4	CH3	CH2	CH1
(2)								(1)							

(1) 0: Alert output enable, 1: Alert output disable

(2) b4 to b15 of the R60DA4 and b8 to b15 of the R60DAV8 and R60DAI8 are fixed to 0.

■Buffer memory address

The following shows the buffer memory address of this area.

Buffer memory name	CH1	CH2	CH3	CH4	CH5	CH6	CH7	CH8
Disconnection detection/Alert output setting	47							

■Enabling the setting

Turn on and off 'Operating condition setting request' (Y9) to enable the setting.

■Default value

The default value is Alert output disable (1) for all channels.

CH1 Rate control enable/disable setting

Set whether to enable or disable the rate control.

For the rate control function, refer to the following.

☞ Page 30 Rate Control Function

Setting value	Description
0	Enable
1	Disable

If a value other than the above is set, a rate control enable/disable setting range error (error code: 1B8□H) occurs.

The rate control function cannot be used when the wave output function is used. In the channel for which Enable (0) is set while the wave output function is being used, a rate control setting error in wave output mode (alarm code: 0B3□H) occurs.

■Buffer memory address

The following shows the buffer memory address of this area.

Buffer memory name	CH1	CH2	CH3	CH4	CH5	CH6	CH7	CH8
CH□ Rate control enable/disable setting	509	709	909	1109	1309	1509	1709	1909

■Enabling the setting

Turn on and off 'Operating condition setting request' (Y9) to enable the setting.

■Default value

The default value is Disable (1) for all channels.

Rate control enable/disable setting [Q compatible mode]

When the Q compatible mode function is used, set whether to enable or disable the rate control.

The following shows the setting details in the Q compatible mode.

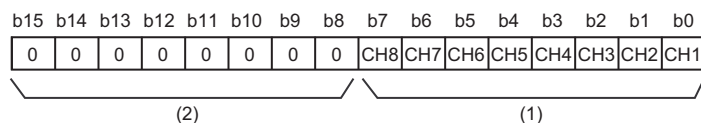

(1) 0: Rate control enable, 1: Rate control disable

(2) b4 to b15 of the R60DA4 and b8 to b15 of the R60DAV8 and R60DAI8 are fixed to 0.

■Buffer memory address

The following shows the buffer memory address of this area.

Buffer memory name	CH1	CH2	CH3	CH4	CH5	CH6	CH7	CH8
Rate control enable/disable setting	46							

CH1 Alert output upper limit value

Set the range of digital values to output alerts.

For the alert output function, refer to the following.

☞ Page 28 Alert Output Function

■Buffer memory address

The following shows the buffer memory address of this area.

Buffer memory name	CH1	CH2	CH3	CH4	CH5	CH6	CH7	CH8
CH□ Alert output upper limit value	510	710	910	1110	1310	1510	1710	1910
CH□ Alert output upper limit value (When the Q compatible mode function is used)	86	88	90	92	94	96	98	100

■Setting range

The setting range is from -32768 to 32767. In the channel where a set value does not satisfy the condition "alert output upper limit value > alert output lower limit value", an alert output upper/lower limit value inversion error (error code: 1B1□H) occurs. When 'CH1 Alert output setting' (Un\G508) is set to Disable (1), the setting of 'CH1 Alert output upper limit value' (Un\G510) is ignored.

■Enabling the setting

Turn on and off 'Operating condition setting request' (Y9) to enable the setting.

■Default value

The default value is 0 for all channels.

■Precautions

When the shift function is used, always set a value in consideration of 'CH1 Input value shift amount' (Un\G480).

CH1 Alert output lower limit value

Set the range of digital values to output alerts.

For the alert output function, refer to the following.

☞ Page 28 Alert Output Function

■Buffer memory address

The following shows the buffer memory address of this area.

Buffer memory name	CH1	CH2	CH3	CH4	CH5	CH6	CH7	CH8
CH□ Alert output lower limit value	512	712	912	1112	1312	1512	1712	1912
CH□ Alert output lower limit value (When the Q compatible mode function is used)	87	89	91	93	95	97	99	101

■Setting range

The setting range is from -32768 to 32767. In the channel where a set value does not satisfy the condition "alert output upper limit value > alert output lower limit value", an alert output upper/lower limit value inversion error (error code: 1B1□H) occurs. When 'CH1 Alert output setting' (Un\G508) is set to Disable (1), the setting of 'CH1 Alert output lower limit value' (Un\G512) is ignored.

■Enabling the setting

Turn on and off 'Operating condition setting request' (Y9) to enable the setting.

■Default value

The default value is 0 for all channels.

■Precautions

When the shift function is used, always set a value in consideration of 'CH1 Input value shift amount' (Un\G480).

CH1 Increase digital limit value

Set the increment value per conversion cycle (80μs) when using the rate control function.

For the rate control function, refer to the following.

☞ Page 30 Rate Control Function

■Buffer memory address

The following shows the buffer memory address of this area.

Buffer memory name	CH1	CH2	CH3	CH4	CH5	CH6	CH7	CH8
CH□ Increase digital limit value	514	714	914	1114	1314	1514	1714	1914
CH□ Increase digital limit value (When the Q compatible mode function is used)	70	72	74	76	78	80	82	84

■Setting range

The setting range is from 0 to 64000 (FA00H). If a value out of the setting range is set for a channel where the conversion and rate control are enabled, a digital limit value range error (error code: 1B9□H) occurs.

When the scaling setting is enabled, the increase digital limit value of the input digital value converted within the scaling range is applied.

■Enabling the setting

Turn on and off 'Operating condition setting request' (Y9) to enable the setting.

■Default value

The default value is 64000 for all channels.

■Precautions

When a value exceeding 32767 is set in 'CH1 Increase digital limit value' (Un\G514) with the program, the value must be input in hexadecimal.

CH1 Decrease digital limit value

Set the increment value per conversion cycle (80μs) when using the rate control function.

For the rate control function, refer to the following.

☞ Page 30 Rate Control Function

■Buffer memory address

The following shows the buffer memory address of this area.

Buffer memory name	CH1	CH2	CH3	CH4	CH5	CH6	CH7	CH8
CH□ Decrease digital limit value	516	716	916	1116	1316	1516	1716	1916
CH□ Decrease digital limit value (When the Q compatible mode function is used)	71	73	75	77	79	81	83	85

■Setting range

The setting range is from 0 to 64000 (FA00H). If a value out of the setting range is set for a channel where the conversion and rate control are enabled, a digital limit value range error (error code: 1B9□H) occurs.

When the scaling setting is enabled, the decrease digital limit value of the input digital value converted within the scaling range is applied.

■Enabling the setting

Turn on and off 'Operating condition setting request' (Y9) to enable the setting.

■Default value

The default value is 64000 for all channels.

■Precautions

When a value exceeding 32767 is set in 'CH1 Decrease digital limit value' (Un\G516) with the program, the value must be input in hexadecimal.

CH1 Output setting during wave output stop

Select the output during wave output stop when the wave output function is used.

The setting for this area is enabled only in the wave output mode. In other modes, changing the setting value is ignored.

Analog output	Setting value
0V/0mA	0
Offset value	1
Output value during wave output stop ^{*1}	2

*1 Set value of 'CH1 Output value during wave output stop' (Un\G525)

In the channel where a value out of the setting range is set, an output setting during wave output stop setting range error (error code: 1D2□H) occurs and 'Error flag' (XF) turns on. The operation of the wave output before the change continues.

When Output value during wave output stop (2) is set for this area, set a value in 'CH1 Output value during wave output stop' (Un\G525).

■Buffer memory address

The following shows the buffer memory address of this area.

Buffer memory name	CH1	CH2	CH3	CH4	CH5	CH6	CH7	CH8
CH□ Output setting during wave output stop	524	724	924	1124	1324	1524	1724	1924
CH□ Output setting during wave output stop (When the Q compatible mode function is used)	1008	1009	1010	1011	1012	1013	1014	1015

■Enabling the setting

Turn on and off 'Operating condition setting request' (Y9) to enable the setting.

■Default value

The default value is Offset value (1) for all channels.

CH1 Output value during wave output stop

This area is for setting the value to be output when Output value during wave output stop (2) is set in 'CH1 Output setting during wave output stop' (Un\G524).

The setting for this area is enabled only in the wave output mode. In other modes, changing the setting value is ignored. The setting range depends on the set output range. Configure the setting in the following range.

Output range	Setting range
0 to 5V	0 to 32767 (practical range: 0 to 32000)
1 to 5V	
0 to 20mA	
4 to 20mA	
-10 to 10V	-32768 to 32767 (practical range: -32000 to 32000)

In the channel where a value out of the setting range is set, an output value during wave output stop setting range error (error code: 1D3□H) occurs and 'Error flag' (XF) turns on. The wave output does not start.

However, when a value other than Output value during wave output stop (2) is set in 'CH1 Output setting during wave output stop' (Un\G524), the above error does not occur.

Since the default value is 0, change the setting value if 'CH1 Output setting during wave output stop' (Un\G524) is set to Output value during wave output stop (2).

■Buffer memory address

The following shows the buffer memory address of this area.

Buffer memory name	CH1	CH2	CH3	CH4	CH5	CH6	CH7	CH8
CH□ Output value during wave output stop	525	725	925	1125	1325	1525	1725	1925
CH□ Output value during wave output stop (When the Q compatible mode function is used)	1016	1017	1018	1019	1020	1021	1022	1023

■Enabling the setting

Turn on and off 'Operating condition setting request' (Y9) to enable the setting.

■Default value

The default value is 0 for all channels.

CH1 Wave pattern start address setting

This area is for setting the start address of the wave pattern to be output when the wave output function is used.

The setting for this area is enabled only in the wave output mode. In other modes, changing the setting value is ignored.

In the channel where the set values in this area and in 'CH1 Wave pattern data points setting' (Un\G528, Un\G529) satisfy the following conditions, a wave data registry area range error (error code: 1D9□H) occurs and 'Error flag' (XF) turns on. The wave output does not start.

(Wave pattern start address setting + Wave pattern data points setting - 1) > 89999 (the last buffer memory address of the wave data registry area)

■Buffer memory address

The following shows the buffer memory address of this area.

Buffer memory name	CH1	CH2	CH3	CH4	CH5	CH6	CH7	CH8
CH□ Wave pattern start address setting	526 527	726 727	926 927	1126 1127	1326 1327	1526 1527	1726 1727	1926 1927
CH□ Wave pattern start address setting (When the Q compatible mode function is used)	1024	1026	1028	1030	1032	1034	1036	1038

■Setting range

The setting range is from 10000 to 89999 (10000 to 89999 of the buffer memory).

In the channel where a value out of the setting range is set, a wave pattern start address setting range error (error code: 1D4□H) occurs and 'Error flag' (XF) turns on. The wave output does not start.

■Enabling the setting

Turn on and off 'Operating condition setting request' (Y9) to enable the setting.

■Default value

The default value is 10000 for all channels.

CH1 Wave pattern data points setting

This area is for setting the data points of the wave pattern to be output when the wave output function is used.

The setting for this area is enabled only in the wave output mode. In other modes, changing the setting value is ignored.

In the channel where the set values in this area and in 'CH1 Wave pattern data points setting' (Un\G528, Un\G529) satisfy the following conditions, a wave data registry area range error (error code: 1D9□H) occurs and 'Error flag' (XF) turns on. The wave output does not start.

(Wave pattern start address setting + Wave pattern data points setting - 1) > 89999 (the last buffer memory address of the wave data registry area)

■Buffer memory address

The following shows the buffer memory address of this area.

Buffer memory name	CH1	CH2	CH3	CH4	CH5	CH6	CH7	CH8
CH□ Wave pattern data points setting	528 529	728 729	928 929	1128 1129	1328 1329	1528 1529	1728 1729	1928 1929
CH□ Wave pattern data points setting (When the Q compatible mode function is used)	1040	1042	1044	1046	1048	1050	1052	1054

■Setting range

The setting range is from 1 to 80000 (the number of data points of the wave data registry area).

In the channel where a value out of the setting range is set, a wave pattern data points setting range error (error code: 1D5□H) occurs and 'Error flag' (XF) turns on. The wave output does not start.

However, when the value of 'CH1 Wave pattern start address setting' (Un\G526, Un\G527) is out of the setting range, the above error does not occur.

■Enabling the setting

Turn on and off 'Operating condition setting request' (Y9) to enable the setting.

■Default value

The default value is 0 for all channels.

CH1 Wave pattern output repetition setting

This area is for setting the number of wave pattern outputs when the wave output function is used.

The setting for this area is enabled only in the wave output mode. In other modes, changing the setting value is ignored.

Setting value	Description
-1	The wave pattern is output in analog unlimitedly.
1 to 32767	The wave pattern is output in analog for the set number.

In the channel where a value out of the setting range is set, a wave pattern output repetition setting range error (error code: 1D6□H) occurs and 'Error flag' (XF) turns on. The wave output does not start.

■Buffer memory address

The following shows the buffer memory address of this area.

Buffer memory name	CH1	CH2	CH3	CH4	CH5	CH6	CH7	CH8
CH□ Wave pattern output repetition setting	530	730	930	1130	1330	1530	1730	1930
CH□ Wave pattern output repetition setting (When the Q compatible mode function is used)	1056	1057	1058	1059	1060	1061	1062	1063

■Enabling the setting

Turn on and off 'Operating condition setting request' (Y9) to enable the setting.

■Default value

The default value is 1 (time) for all channels.

CH1 Constant for wave output conversion cycle

This area is for setting the constant to determine the conversion cycle (specifying a multiple of the conversion speed) for each channel when the wave output function is used.

The setting for this area is enabled only in the wave output mode. In other modes, changing the setting value is ignored.

The conversion cycle of each channel is determined from the combination of the reference conversion speed (80 μ s), number of channels where D/A conversion is enabled, and the constant for wave output conversion cycle.

- "Conversion cycle" = "Reference conversion speed (80 μ s) \times "Number of channels where D/A conversion is enabled" \times "Constant for wave output conversion cycle"

■Buffer memory address

The following shows the buffer memory address of this area.

Buffer memory name	CH1	CH2	CH3	CH4	CH5	CH6	CH7	CH8
CH□ Constant for wave output conversion cycle	531	731	931	1131	1331	1531	1731	1931
CH□ Constant for wave output conversion cycle (When the Q compatible mode function is used)	1064	1065	1066	1067	1068	1069	1070	1071

■Setting range

The setting range is from 1 to 5000.

In the channel where a value out of the setting range is set, a wave output conversion cycle setting range error (error code: 1D7□H) occurs and 'Error flag' (XF) turns on. The wave output does not start.

■Enabling the setting

Turn on and off 'Operating condition setting request' (Y9) to enable the setting.

■Default value

The default value is 1 for all channels.

CH1 Range setting

This area is for setting an output range.

Output range	Setting value		
	R60DA4	R60DAV8	R60DAI8
4 to 20mA	0H	—	0H
0 to 20mA	1H	—	1H
1 to 5V	2H	0H, 2H	—
0 to 5V	3H	3H	—
-10 to 10V	4H	4H	—
User range setting (voltage)	EH	EH	—
User range setting (current)	FH	—	FH

If a value other than the above is set, a range setting range error (error code: 190□H) occurs.

If the range switching is attempted with the D/A conversion and output enabled for the purpose of preventing a sudden change in the analog output, CH□ Under-output range change denial alarm (alarm code: 0C0□H) occurs and the range switching is not executed. To execute the range switching, turn off 'CH1 Output enable/disable flag' (Y1).

The user range cannot be used when the wave output function is used. Even within the setting range in the above table, when the user range is set while the wave output function is used, a user range specification error in wave output mode (error code: 1D0□H) occurs and the wave output does not start.

The output range cannot be changed for channels set to D/A conversion disabled. To change the output range, set 'CH1 D/A conversion enable/disable setting' (Un\G500) to D/A conversion enabled (0), set 'CH1 Output enable/disable flag' (Y1) to OFF, and turn on and off 'Operating condition setting request' (Y9).

■Buffer memory address

The following shows the buffer memory address of this area.

Buffer memory name	CH1	CH2	CH3	CH4	CH5	CH6	CH7	CH8
CH□ Range setting	598	798	998	1198	1398	1598	1798	1998

■Enabling the setting

Turn on and off 'Operating condition setting request' (Y9) to enable the setting.

Range setting [Q compatible mode]

This area is for setting an output range when the Q compatible mode function is used.

The following shows the setting details in the Q compatible mode.

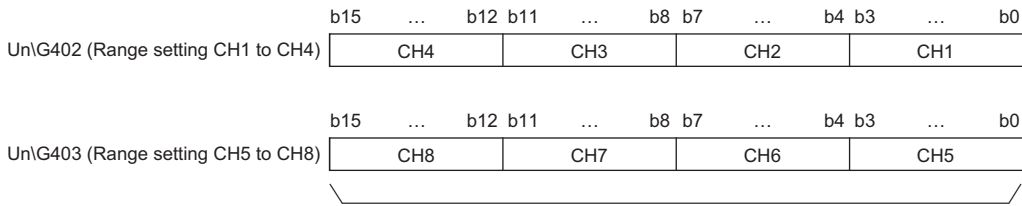

(1)

(1) The buffer memory address 403 of R60DA4 is fixed to 0.

Output range	Setting value		
	R60DA4	R60DAV8	R60DAI8
4 to 20mA	0H	—	0H
0 to 20mA	1H	—	1H
1 to 5V	2H	0H, 2H	—
0 to 5V	3H	3H	—
-10 to 10V	4H	4H	—
User range setting (voltage)	EH	EH	—
User range setting (current)	FH	—	FH

The output range cannot be changed for channels set to D/A conversion disabled. To change the output range, set the bit of the corresponding channel of 'CH1 D/A conversion enable/disable setting [Q compatible mode]' (Un\G0) to D/A conversion enabled (0), set 'CH1 Output enable/disable flag' (Y1) to OFF, and turn on and off 'Operating condition setting request' (Y9).

■Buffer memory address

The following shows the buffer memory address of this area.

Buffer memory name	CH1	CH2	CH3	CH4	CH5	CH6	CH7	CH8
Range setting	402				403			

■Enabling the setting

Turn on and off 'Operating condition setting request' (Y9) to enable the setting.

Error history

Up to 16 errors that occurred in the module are recorded.

	b15	to	b8	b7	to	b0
Un\G3600	Error code					
Un\G3601	First two digits of the year			Last two digits of the year		
Un\G3602	Month			Day		
Un\G3603	Hour			Minute		
Un\G3604	Second			Day of the week		
Un\G3605	Millisecond (Upper)			Millisecond (Lower)		
Un\G3606	System area					
to						
Un\G3609						

Item	Storage contents	Storage example* ¹
First two digits of the year/Last two digits of the year	Stored in BCD code.	2014H
Month/Day		630H
Hour/Minute		1234H
Second		56H
Day of the week	One of the following values is stored in BCD code. Sunday: 0, Monday: 1, Tuesday: 2, Wednesday: 3 Thursday: 4, Friday: 5, Saturday: 6	1H
Millisecond (upper)	Stored in BCD code.	7H
Millisecond (lower)		89H

*1 Values stored when an error occurs at 12:34:56.789 on Monday, June 30th, 2014.

■ Buffer memory address

The following shows the buffer memory address of this area.

Buffer memory name	No.1 to No.16
Error history	3600 to 3759
Error history (When the Q compatible mode function is used)	1810 to 1969

Alarm history

Up to 16 alarms that occurred in the module are recorded.

	b15	to	b8	b7	to	b0
Un\G3760	Alarm code					
Un\G3761	First two digits of the year			Last two digits of the year		
Un\G3762	Month			Day		
Un\G3763	Hour			Minute		
Un\G3764	Second			Day of the week		
Un\G3765	Millisecond (Upper)			Millisecond (Lower)		
Un\G3766	System area					
to						
Un\G3769						

Item	Storage contents	Storage example*1
First two digits of the year/Last two digits of the year	Stored in BCD code.	2014H
Month/Day		630H
Hour/Minute		1234H
Second		56H
Day of the week	One of the following values is stored in BCD code. Sunday: 0, Monday: 1, Tuesday: 2, Wednesday: 3 Thursday: 4, Friday: 5, Saturday: 6	1H
Millisecond (upper)	Stored in BCD code.	7H
Millisecond (lower)		89H

*1 Values stored when an alarm occurs at 12:34:56.789 on Monday, June 30th, 2014.

■ Buffer memory address

The following shows the buffer memory address of this area.

Buffer memory name	No.1 to No.16
Alarm history	3760 to 3919
Alarm history (When the Q compatible mode function is used)	3760 to 3919

Save data type setting

This area saves and restores the offset/gain setting value in user range setting.

Only the R60DA4 can use this area.

b15	b14	b13	b12	b11	b10	b9	b8	b7	b6	b5	b4	b3	b2	b1	b0
0	0	0	0	0	0	0	0	0	0	0	0	CH4	CH3	CH2	CH1
(2)												(1)			

(1) 0: User range setting (voltage), 1: User range setting (current)

(2) b4 to b15 are fixed to 0.

■ Buffer memory address

The following shows the buffer memory address of this area.

Buffer memory name	CH1	CH2	CH3	CH4	CH5	CH6	CH7	CH8
Save data type setting	4002							
Save data type setting (When the Q compatible mode function is used)	200							

■ Default value

The default value is 0 for all channels.

CH1 Factory default setting

This area restores the offset/gain setting value in user range setting. For details, refer to the following.

☞ Page 168 CH1 User range setting

CH1 User range setting

This area restores the offset/gain setting value in user range setting.

■ Buffer memory address

The following shows the buffer memory address of this area.

- For the R60DA4

Buffer memory name	CH1	CH2	CH3	CH4
CH□ Factory default setting offset value	4004	4006	4008	4010
CH□ Factory default setting gain value	4005	4007	4009	4011
CH□ User range setting offset value	4012	4014	4016	4018
CH□ User range setting gain value	4013	4015	4017	4019
CH□ Factory default setting offset value (When the Q compatible mode function is used)	202	204	206	208
CH□ Factory default setting gain value (When the Q compatible mode function is used)	203	205	207	209
CH□ User range setting offset value (When the Q compatible mode function is used)	210	212	214	216
CH□ User range settings gain value (When the Q compatible mode function is used)	211	213	215	217

- For the R60DAV8 and R60DAI8

Buffer memory name	CH1	CH2	CH3	CH4	CH5	CH6	CH7	CH8
CH□ Factory default setting offset value	4004	4006	4008	4010	4012	4014	4016	4018
CH□ Factory default setting gain value	4005	4007	4009	4011	4013	4015	4017	4019
CH□ User range setting offset value	4020	4022	4024	4026	4028	4030	4032	4034
CH□ User range setting gain value	4021	4023	4025	4027	4029	4031	4033	4035
CH□ Factory default setting offset value (When the Q compatible mode function is used)	202	204	206	208	210	212	214	216
CH□ Factory default setting gain value (When the Q compatible mode function is used)	203	205	207	209	211	213	215	217
CH□ User range setting offset value (When the Q compatible mode function is used)	218	220	222	224	226	228	230	232
CH□ User range settings gain value (When the Q compatible mode function is used)	219	221	223	225	227	229	231	233

When the following operations are performed, the data to be used is stored (saved).

- Writing the initial setting by engineering tool
- Turning off and on Operating condition setting request (Y9) (Data is not saved when the mode is switched from the normal mode to the offset/gain setting mode by the mode switching setting.)
- Writing an offset/gain value in the offset/gain setting mode (When User range write request (YA) is turned off and on)

When restoring the offset/gain setting value in user range setting, set the same data as the saved data in this area to the corresponding area of the D/A converter module that is the restoration destination.

For the offset/gain setting, refer to the following.

📖 MELSEC iQ-R Digital-Analog Converter Module User's Manual (Startup)

■ Default value

The default value is 0 for all channels.

Offset/gain adjustment value specification

Set the adjustment amount of the analog output value in the offset/gain setting mode.

For the offset/gain setting, refer to the following.

 MELSEC iQ-R Digital-Analog Converter Module User's Manual (Startup)

■Buffer memory address

The following shows the buffer memory address of this area.

Buffer memory name	CH1	CH2	CH3	CH4	CH5	CH6	CH7	CH8
Offset/gain adjustment value specification	4130							
Offset/gain adjustment value specification (When the Q compatible mode function is used)	24							

■Setting range

The setting range is from -3000 to 3000.

Ex.

When the setting value is 1000

The analog output value is adjusted to approx. 0.31V (in voltage output) or approx. 0.35mA (in current output).

Point

When the offset/gain setting is configured from the offset/gain setting window of an engineering tool, the setting is performed properly on the window. Therefore, a program is not required to perform the setting. To configure the offset/gain setting from a program, set the offset/gain setting mode (offset specification) and offset/gain setting mode (gain specification). For details, refer to the following.

 Digital-Analog Converter Module User's Manual

CH1 Offset/gain setting mode

Specify the channel where the offset/gain setting is adjusted.

- Offset/gain setting mode (offset specification): Channel to adjust the offset
- Offset/gain setting mode (gain specification): Channel to adjust the gain

Setting value	Description
0	Disable
1	Setting channel

Multiple channels cannot be set at the same time. Set Disable (0) in Offset/gain setting mode (offset specification) or in Offset/gain setting mode (gain specification).

When a value other than the above is set, Offset/gain setting channel range error (error code: 1E8□H) occurs.

In the following cases, an offset/gain setting channel specification error (error code: 1E50H) occurs.

- When Setting channel (1) is set for both of Offset/gain setting mode (offset specification) and Offset/gain setting mode (gain specification) of the same channel
- When Disable (0) is set for all channels
- When multiple channels are set at the same time

■Buffer memory address

The following shows the buffer memory address of this area.

Buffer memory name	CH1	CH2	CH3	CH4	CH5	CH6	CH7	CH8
CH□ Offset/gain setting mode (offset specification)	4132	4134	4136	4138	4140	4142	4144	4146
CH□ Offset/gain setting mode (gain specification)	4133	4135	4137	4139	4141	4143	4145	4147

■Enabling the setting

Turn off and on 'Channel change request' (YB).

■Default value

The default value is Disable (0) for all channels.

Offset/gain setting mode [Q compatible mode]

When the Q compatible mode function is used, specify the channel where the offset/gain setting is adjusted.

The following shows the setting details in the Q compatible mode.

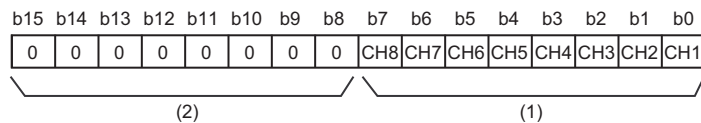

(1) 0: Disable, 1: Setting channel

(2) b4 to b15 of the R60DA4 and b8 to b15 of the R60DAV8 and R60DAI8 are fixed to 0.

■Buffer memory address

The following shows the buffer memory address of this area.

Buffer memory name	CH1	CH2	CH3	CH4	CH5	CH6	CH7	CH8
Offset/gain setting mode (offset specification)	22							
Offset/gain setting mode (gain specification)	23							

■Enabling the setting

Turn off and on 'Channel change request' (YB).

■Default value

The default value is Disable (0) for all channels.

Point

When the offset/gain setting is configured from the offset/gain setting window of an engineering tool, the setting is performed properly on the window. Therefore, a program is not required to perform the setting. To configure the offset/gain setting from a program, set the offset/gain setting mode (offset specification) and offset/gain setting mode (gain specification). For details, refer to the following.

 Digital-Analog Converter Module User's Manual

CH1 Offset/gain setting mode (range specification)

The output range can be changed in the offset/gain setting.

The output range is changed to the set one by 'Channel change request' (YB).

Setting value	Description
E	User range setting (voltage)
F	User range setting (current)

When a value other than the above is set, an offset/gain setting range error (error code: 1E9□H) occurs.

■Buffer memory address

The following shows the buffer memory address of this area.

Buffer memory name	CH1	CH2	CH3	CH4	CH5	CH6	CH7	CH8
CH□ Offset/gain setting mode (range specification)	4164	4165	4166	4167	4168	4169	4170	4171

Offset/gain setting mode (range specification) [Q compatible mode]

The output range can be changed in the offset/gain setting when the Q compatible mode function is used.

The output range is changed to the set one by 'Channel change request' (YB).

The setting written in 'Offset/gain setting mode (range specification)' (Un\G25) is applied to all the channels.

Setting value	Description
E	User range setting (voltage)
F	User range setting (current)

■Buffer memory address

The following shows the buffer memory address of this area.

Buffer memory name	CH1	CH2	CH3	CH4	CH5	CH6	CH7	CH8
Offset/gain setting mode (range specification)	25							

Point

When the offset/gain setting is configured from the offset/gain setting window of an engineering tool, the setting is performed properly on the window. Therefore, a program is not required to perform the setting.

To configure the offset/gain setting from a program, set the offset/gain setting mode (offset specification) and offset/gain setting mode (gain specification). For details, refer to the following.

 Digital-Analog Converter Module User's Manual

CH1 Synchronization digital value

When the inter-module synchronization function is enabled, the D/A conversion is performed to the digital value set in this area in the inter-module synchronization cycle, and the value is output in the analog format in the next inter-module synchronization cycle.

Output range setting	When the scaling function is disabled	When the scaling function is enabled ^{*1}
	Setting range (practical range)	Setting range
0: 4 to 20mA	-768 to 32767 (practical range: 0 to 32000)	-32000 to 32000
1: 0 to 20mA		
2: 1 to 5V		
3: 0 to 5V	-32768 to 32767 (practical range: -32000 to 32000)	
4: -10 to 10V		
E: User range setting (voltage)		
F: User range setting (current)		

*1 The available setting range and practical range of when the scaling function is enabled differ depending on the setting of the scaling upper limit value and scaling lower limit value.

When a value out of the available setting range is written, the D/A conversion is performed with the upper or lower limit value of the available setting range. A check code is stored in 'CH1 Setting value check code' (Un\G400) and a digital value setting range error (error code: 191□H) is stored in 'Latest error code' (Un\G0).

■Buffer memory address

The following shows the buffer memory address of this area.

Buffer memory name	CH1	CH2	CH3	CH4	CH5	CH6	CH7	CH8
CH□ Synchronization digital value	9500	9502	9504	9506	9508	9510	9512	9514
CH□ Synchronization digital value (When the Q compatible mode function is used)	2000	2002	2004	2006	2008	2010	2012	2014

A

Output setting during synchronous Error

Select whether to continue or stop the synchronization of the D/A converter modules when an inter-module synchronization cross-cycles processing error (error code: 2600H) or inter-module synchronization signal error (error code: 2610H) occurs.

Setting value	Description
0	Synchronization continues
1	Synchronization stops

■Buffer memory address

The following shows the buffer memory address of this area.

Buffer memory name	CH1	CH2	CH3	CH4	CH5	CH6	CH7	CH8
Output setting during synchronous Error	9532							
Output setting during synchronous Error (When the Q compatible mode function is used)	2032							

■Enabling the setting

Turn on and off 'Operating condition setting request' (Y9) to enable the setting.

■Default value

The default value is Synchronization continues (0).

Synchronization status monitor

This area is for checking whether the D/A converter module is set as a target or a non-target of the inter-module synchronization function, and the inter-module synchronization status (synchronization in progress/during synchronization) when the inter-module synchronization function is used.

Monitor value	Description
0	Inter-module synchronization non-target
1	Inter-module synchronization target (synchronization at rest)
2	Inter-module synchronization target (during synchronization)

■Buffer memory address

The following shows the buffer memory address of this area.

Buffer memory name	CH1	CH2	CH3	CH4	CH5	CH6	CH7	CH8
Synchronization status monitor	9600							
Synchronization status monitor (When the Q compatible mode function is used)	2100							

Wave data registry area

This area is for registering wave data for analog output in the wave output mode.

The setting range depends on the set output range. The setting range is shown below.

Output range	Setting range
4 to 20mA	-768 to 32767 (practical range: 0 to 32000)
0 to 20mA	
1 to 5V	
0 to 5V	
-10 to 10V	-32768 to 32767 (practical range: -32000 to 32000)

In the channel where the wave data with a value out of the above setting range set is output, a digital value setting range error (error code: 191□H) occurs and 'Error flag' (XF) turns on. The wave output operations continue to be performed. However, the analog output value corresponding to a digital input value out of the setting range is fixed to the maximum or minimum value of the output range.

■Buffer memory address

The following shows the buffer memory address of this area.

Buffer memory name	CH1	CH2	CH3	CH4	CH5	CH6	CH7	CH8
Wave data registry area	10000 to 89999							
Wave data registry area (When the Q compatible mode function is used)	10000 to 89999							

Appendix 4 Dedicated Instruction

Instruction list

The following table lists the dedicated instructions that can be used in the D/A converter module.

Instruction	Description
G(P).OFFGAN	Switches normal mode to offset/gain setting mode. Switches offset/gain setting mode to normal mode.
G(P).OGLOAD	The offset/gain setting value in the user range setting is read out to the CPU module.
G(P).OGSTOR	Restores the offset/gain setting value in the user range setting stored in the CPU module into the D/A converter module.

For details on the dedicated instructions, refer to the following.

 MELSEC iQ-R Programming Manual (Module Dedicated Instructions)

Appendix 5 Operation Examples of When the Remote Head Module Is Mounted

This section describes operation examples of when the remote head module is mounted.

System configuration example

The following system configuration is used to explain an example of operation.

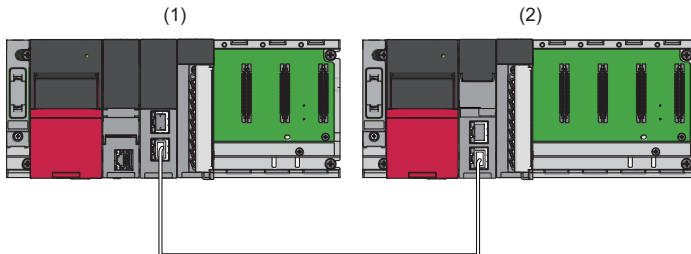

(1) Master station (Network number 1, station number 0)

- Power supply module: R61P
- CPU module: R04CPU
- Master/local module: RJ71GF11-T2 (Start I/O number: 0000H to 001FH)
- Input module: RX10 (Start I/O number: 0020H to 002FH)

(2) Intelligent device station (Network number 1, station number 1)

- Power supply module: R61P
- Remote head module: RJ72GF15-T2
- D/A converter module: R60DA4 (Start I/O number: 0000H to 000FH)^{*1}

*1 In the RX/RX setting of the master station, set 1000H to 100FH as the start I/O number of the D/A converter module.

Setting in the master station

Connect the engineering tool to the CPU module of the master station and set parameters.

1. Create the project with the following settings.

 [Project] ⇒ [New]

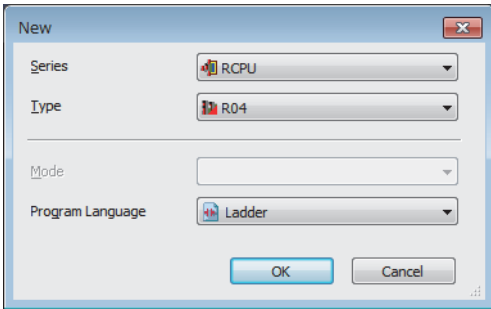

2. Configure the setting to use the module labels and add the module labels of the CPU module.

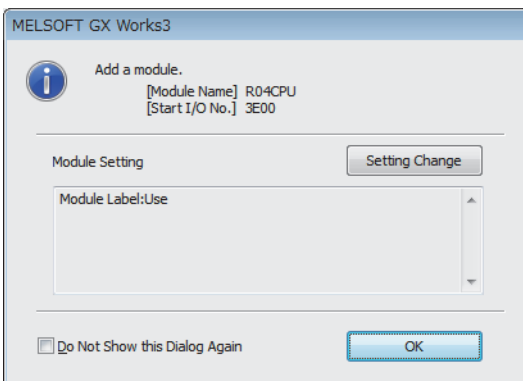

3. Add the master/local module with the following settings.

 [Navigation window] ⇒ [Parameter] ⇒ [Module Information] ⇒ Right-click ⇒ [Add New Module]

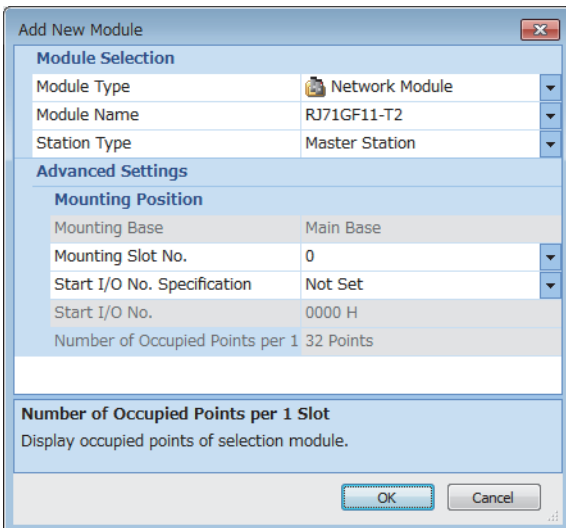

4. Configure the setting to use the module labels and add the module labels of the master/local module.

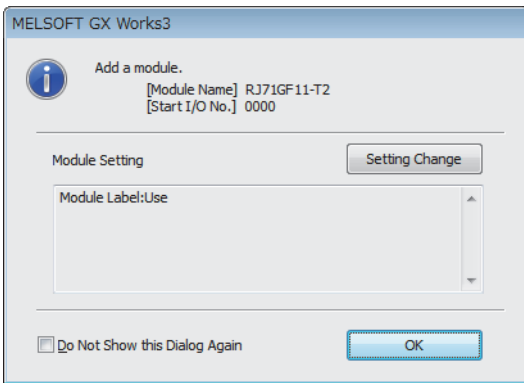

5. Set "Required Settings" of "Module Parameter" of the master/local module as shown below.

[Navigation window] ⇒ [Parameter] ⇒ [Module Information] ⇒ [RJ71GF11-T2] ⇒ [Module Parameter] ⇒ [Required Settings]

Item	Setting
Station Type	
Station Type	Master Station
Network Number	
Network Number	1
Station Number	
Setting Method	Parameter Editor
Station No.	0
Parameter Setting Method	
Setting Method of Basic/Application Settings	Parameter Editor

6. Set "Network Configuration Settings" of "Module Parameter" of the master/local module as shown below.







[Navigation window] ⇒ [Parameter] ⇒ [Module Information] ⇒ [RJ71GF11-T2] ⇒ [Module Parameter] ⇒ [Basic Settings] ⇒ [Network Configuration Settings]

No.	Model Name	STA#	Station Type	RX/RX Setting			RWw/RW Setting			Reserved/Error Invalid Station/System Switching Monitoring Target Station	Pairing	Network Synchronous Communication	Alias	Comment	Station-specific mode setting
				Points	Start	End	Points	Start	End						
0	Host Station	0	Master Station												
1	RJ72GF15-T2	1	Intelligent Device Station	256	0000	00FF	256	0000	00FF	No Setting		Asynchronous			



7. Set "Refresh Setting" of "Module Parameter" of the master/local module as shown below.

 [Navigation window] ⇒ [Parameter] ⇒ [Module Information] ⇒ [RJ71GF11-T2] ⇒ [Module Parameter] ⇒ [Basic Settings] ⇒ [Refresh Setting]

No.	Link Side					CPU Side				
	Device Name	Points	Start	End		Target	Device Name	Points	Start	End
-	SB	512	00000	001FF		Module Label				
-	SW	512	00000	001FF		Module Label				
1	RX	256	00000	000FF		Specify Device	X	256	01000	010FF
2	RY	256	00000	000FF		Specify Device	Y	256	01000	010FF
3	RWw	256	00000	000FF		Specify Device	W	256	00000	000FF
4	RWt	256	00000	000FF		Specify Device	W	256	01000	010FF

8. Write the set parameters to the CPU module on the master station. Then reset the CPU module or power off and on the system.

 [Online] ⇒ [Write to PLC]

Point 

For parameters of the master/local module which are not described in this procedure, set default values. For details on parameters of the master/local module, refer to the following.

 MELSEC iQ-R CC-Link IE Field Network User's Manual (Application)

Setting in the intelligent device station

Connect the engineering tool to the remote head module of the intelligent device station and set parameters.

1. Create the project with the following settings.

[Project] ⇒ [New]

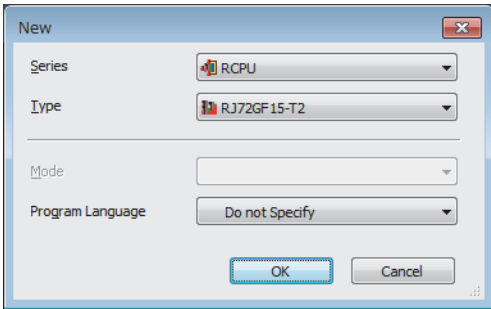

2. Set "Network Required Setting" of "CPU Parameter" of the remote head module as shown below.

[Navigation window] ⇒ [Parameter] ⇒ [RJ72GF15-T2] ⇒ [CPU Parameter] ⇒ [Network Required Setting]

Item	Setting
Network Number	
Network Number	1
Station Number	
Station No.	1

3. Add the D/A converter module with the following settings.

[Navigation window] ⇒ [Parameter] ⇒ [Module Information] ⇒ Right-click ⇒ [Add New Module]

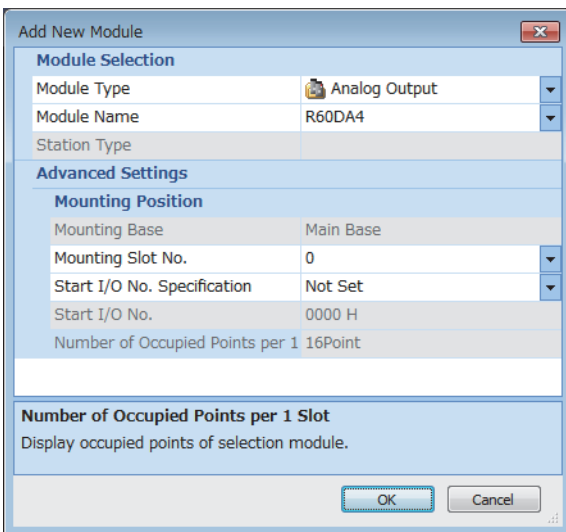

4. Configure the setting not to use the module labels.

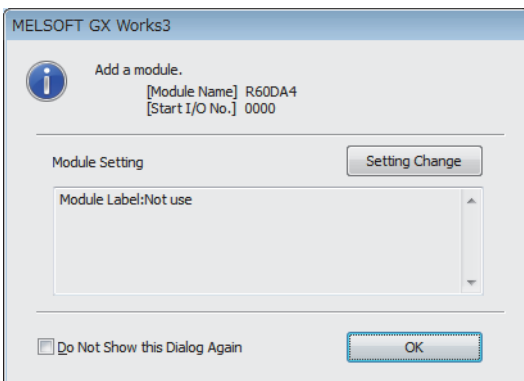

A

5. Set "Basic setting" of "Module Parameter" of the D/A converter module as shown below.

[Navigation window] ⇒ [Parameter] ⇒ [Module Information] ⇒ [R60DA4] ⇒ [Module Parameter] ⇒ [Basic setting]

Setting Item				
Item	CH1	CH2	CH3	CH4
Range switching function	This function enables to select the output range to be used from multiple ranges.			
Output range setting	-10 to 10V	-10 to 10V	0 to 20mA	4 to 20mA
Operation mode setting function	The two operation modes, "Normal mode" to execute the D/A conversion and "Offset/gain setting mode" to execute t			
Operation mode setting	Normal mode (D/A conversion process)			
Output mode setting	Normal output mode			
Output mode setting function	HOLD or CLEAR can be set in the analog output HOLD/CLEAR setting.			
Analog output HOLD/CLEAR setting	HOLD	HOLD	HOLD	HOLD
D/A conversion enable/disable function	This function sets whether to enable or disable the D/A conversion for each channel.			
D/A conversion enable/disable setting	D/A conversion enable	D/A conversion enable	D/A conversion enable	D/A conversion enable

6. Set "Application setting" of "Module Parameter" of the D/A converter module as shown below.

[Navigation window] ⇒ [Parameter] ⇒ [Module Information] ⇒ [R60DA4] ⇒ [Module Parameter] ⇒ [Application setting]

Setting Item				
Item	CH1	CH2	CH3	CH4
Scaling setting	This function enables to change the upper limit value or lower limit value of the digital value input range to			
Scaling enable/disable setting	Disable	Disable	Enable	Disable
Scaling upper limit value	0	0	16000	0
Scaling lower limit value	0	0	2000	0
Shift function	This function adds the set amount to the digital value. A fine adjustment at the system startup can be easi			
Input value shift amount	0	0	2000	0
Warning output function	This function outputs an Warning when the digital value is outside the setting range.			
Warning output setting	Disable	Enable	Disable	Disable
Warning output upper limit value	0	32000	0	0
Warning output lower limit value	0	0	0	0
Rate control function	This function controls the increasing and decreasing amount of the analog output value per conversion cyc			
Rate control enable/disable setting	Enable	Disable	Disable	Disable
Increase digital limit value	8000	64000	64000	64000
Decrease digital limit value	1600	64000	64000	64000
Inter-module synchronization function	D/A conversion is performed in the inter-module synchronization cycle.			
Output selection during synchronous error	Inter-module synchronization continue			
Online module change	The module can be changed without the system being stopped.			
Auto restore of Offset/ gain setting with the module change	Enable			
CPU error output mode setting	You can be the setting of whether to keep or not to clear the output of the module to the CPU stop error.			
CPU error output mode setting	Hold			

7. Set "Refresh settings" of "Module Parameter" of the D/A converter module as shown below.

 [Navigation window] ⇒ [Parameter] ⇒ [Module Information] ⇒ [R60DA4] ⇒ [Module Parameter] ⇒ [Refresh settings]

Setting Item				
Target	Device			
	Number of transfers to intelligent function module			4
	Number of transfers to CPU			4
Item	CH1	CH2	CH3	CH4
Refresh at the set timing.				
<input type="checkbox"/> Transfer to the intelligent function module.	Transfer the buffer memory data to the specified device.			
Digital value	W1	W2	W3	W4
<input type="checkbox"/> Transfer to the CPU.	Transfer the buffer memory data to the specified device.			
Latest error code	W1010			
Latest address of error history				
Latest alarm code				
Latest address of alarm history				
Interrupt factor detection flag 1				
Interrupt factor detection flag 2				
Interrupt factor detection flag 3				
Interrupt factor detection flag 4				
Interrupt factor detection flag 5				
Interrupt factor detection flag 6				
Interrupt factor detection flag 7				
Interrupt factor detection flag 8				
Interrupt factor detection flag 9				
Interrupt factor detection flag 10				
Interrupt factor detection flag 11				
Interrupt factor detection flag 12				
Interrupt factor detection flag 13				
Interrupt factor detection flag 14				
Interrupt factor detection flag 15				
Interrupt factor detection flag 16				
Set value check code				
Warning output upper flag	W1008			
Warning output lower flag	W1009			
Disconnection detection flag	W1011			
Wave output status monitor				

8. Write the set parameters to the remote head module on the intelligent device station. Then reset the remote head module or power off and on the system.

 [Online] ⇒ [Write to PLC]



Point 

For parameters of the remote head module which are not described in this procedure, set default values. For details on parameters of the remote head module, refer to the following.

 MELSEC iQ-R CC-Link IE Field Network Remote Head Module User's Manual (Application)

Checking the network status

After setting parameters to the master station and the intelligent device station, check whether data link is normally performed between the master station and the intelligent device station. Check the network status using the CC-Link IE Field Network diagnostics of the engineering tool.

For how to perform the CC-Link IE Field Network diagnostics from the master station, refer to the following.

📖 MELSEC iQ-R CC-Link IE Field Network User's Manual (Application)

Program examples

For the program examples, the module labels of the master/local module are used.

Write the programs to the CPU module on the master station.

Classification	Label name	Description	Device																																																																																																																																							
Module label	GF11_1.bSts_DataLinkError	Data link error status of own station	SB0049																																																																																																																																							
	GF11_1.bnSts_DataLinkError_Station[1]	Data link status of each station (station number 1)	SW00B0.0																																																																																																																																							
Label to be defined	Define global labels as shown below:																																																																																																																																									
	<table border="1"> <thead> <tr> <th></th> <th>Label Name</th> <th>Data Type</th> <th>Class</th> <th>Assign (Device/Label)</th> </tr> </thead> <tbody> <tr><td>1</td><td>ModuleREADY</td><td>Bit</td><td>VAR_GLOBAL</td><td>X1 000</td></tr> <tr><td>2</td><td>ExternalPowerSupplyREADYFlag</td><td>Bit</td><td>VAR_GLOBAL</td><td>X1 007</td></tr> <tr><td>3</td><td>DisconnectionDetectionSignal</td><td>Bit</td><td>VAR_GLOBAL</td><td>X1 00D</td></tr> <tr><td>4</td><td>WarningOutputSignal</td><td>Bit</td><td>VAR_GLOBAL</td><td>X1 00E</td></tr> <tr><td>5</td><td>ErrorFlag</td><td>Bit</td><td>VAR_GLOBAL</td><td>X1 00F</td></tr> <tr><td>6</td><td>CH1 OutputEnableDisableFlag</td><td>Bit</td><td>VAR_GLOBAL</td><td>Y1 001</td></tr> <tr><td>7</td><td>CH2 OutputEnableDisableFlag</td><td>Bit</td><td>VAR_GLOBAL</td><td>Y1 002</td></tr> <tr><td>8</td><td>CH3 OutputEnableDisableFlag</td><td>Bit</td><td>VAR_GLOBAL</td><td>Y1 003</td></tr> <tr><td>9</td><td>CH4 OutputEnableDisableFlag</td><td>Bit</td><td>VAR_GLOBAL</td><td>Y1 004</td></tr> <tr><td>10</td><td>WarningOutputClearRequest</td><td>Bit</td><td>VAR_GLOBAL</td><td>Y1 00E</td></tr> <tr><td>11</td><td>ErrorClearRequest</td><td>Bit</td><td>VAR_GLOBAL</td><td>Y1 00F</td></tr> <tr><td>12</td><td>CH1_DigInVal</td><td>Word [Signed]</td><td>VAR_GLOBAL</td><td>W1</td></tr> <tr><td>13</td><td>CH2_DigInVal</td><td>Word [Signed]</td><td>VAR_GLOBAL</td><td>W2</td></tr> <tr><td>14</td><td>CH3_DigInVal</td><td>Word [Signed]</td><td>VAR_GLOBAL</td><td>W3</td></tr> <tr><td>15</td><td>CH4_DigInVal</td><td>Word [Signed]</td><td>VAR_GLOBAL</td><td>W4</td></tr> <tr><td>16</td><td>WarningOutputUpperFlag</td><td>Word [Signed]</td><td>VAR_GLOBAL</td><td>W1 008</td></tr> <tr><td>17</td><td>WarningOutputLowerFlag</td><td>Word [Signed]</td><td>VAR_GLOBAL</td><td>W1 009</td></tr> <tr><td>18</td><td>DisconnectionDetectionFlag</td><td>Word [Signed]</td><td>VAR_GLOBAL</td><td>W1 011</td></tr> <tr><td>19</td><td>CH2_AlmUpLimit</td><td>Bit</td><td>VAR_GLOBAL</td><td>F0</td></tr> <tr><td>20</td><td>CH2_AlmLowLimit</td><td>Bit</td><td>VAR_GLOBAL</td><td>F1</td></tr> <tr><td>21</td><td>CH4_DisconnectDetect</td><td>Bit</td><td>VAR_GLOBAL</td><td>F2</td></tr> <tr><td>22</td><td>DigitWriteSig</td><td>Bit</td><td>VAR_GLOBAL</td><td>X20</td></tr> <tr><td>23</td><td>DADOutputSig</td><td>Bit</td><td>VAR_GLOBAL</td><td>X21</td></tr> <tr><td>24</td><td>WarningOutClrSig</td><td>Bit</td><td>VAR_GLOBAL</td><td>X22</td></tr> <tr><td>25</td><td>ErrResetSig</td><td>Bit</td><td>VAR_GLOBAL</td><td>X23</td></tr> <tr><td>26</td><td>Connect_FormationFlg_St1</td><td>Bit</td><td>VAR_GLOBAL</td><td>M0</td></tr> </tbody> </table>		Label Name	Data Type	Class	Assign (Device/Label)	1	ModuleREADY	Bit	VAR_GLOBAL	X1 000	2	ExternalPowerSupplyREADYFlag	Bit	VAR_GLOBAL	X1 007	3	DisconnectionDetectionSignal	Bit	VAR_GLOBAL	X1 00D	4	WarningOutputSignal	Bit	VAR_GLOBAL	X1 00E	5	ErrorFlag	Bit	VAR_GLOBAL	X1 00F	6	CH1 OutputEnableDisableFlag	Bit	VAR_GLOBAL	Y1 001	7	CH2 OutputEnableDisableFlag	Bit	VAR_GLOBAL	Y1 002	8	CH3 OutputEnableDisableFlag	Bit	VAR_GLOBAL	Y1 003	9	CH4 OutputEnableDisableFlag	Bit	VAR_GLOBAL	Y1 004	10	WarningOutputClearRequest	Bit	VAR_GLOBAL	Y1 00E	11	ErrorClearRequest	Bit	VAR_GLOBAL	Y1 00F	12	CH1_DigInVal	Word [Signed]	VAR_GLOBAL	W1	13	CH2_DigInVal	Word [Signed]	VAR_GLOBAL	W2	14	CH3_DigInVal	Word [Signed]	VAR_GLOBAL	W3	15	CH4_DigInVal	Word [Signed]	VAR_GLOBAL	W4	16	WarningOutputUpperFlag	Word [Signed]	VAR_GLOBAL	W1 008	17	WarningOutputLowerFlag	Word [Signed]	VAR_GLOBAL	W1 009	18	DisconnectionDetectionFlag	Word [Signed]	VAR_GLOBAL	W1 011	19	CH2_AlmUpLimit	Bit	VAR_GLOBAL	F0	20	CH2_AlmLowLimit	Bit	VAR_GLOBAL	F1	21	CH4_DisconnectDetect	Bit	VAR_GLOBAL	F2	22	DigitWriteSig	Bit	VAR_GLOBAL	X20	23	DADOutputSig	Bit	VAR_GLOBAL	X21	24	WarningOutClrSig	Bit	VAR_GLOBAL	X22	25	ErrResetSig	Bit	VAR_GLOBAL	X23	26	Connect_FormationFlg_St1	Bit	VAR_GLOBAL	M0		
	Label Name	Data Type	Class	Assign (Device/Label)																																																																																																																																						
1	ModuleREADY	Bit	VAR_GLOBAL	X1 000																																																																																																																																						
2	ExternalPowerSupplyREADYFlag	Bit	VAR_GLOBAL	X1 007																																																																																																																																						
3	DisconnectionDetectionSignal	Bit	VAR_GLOBAL	X1 00D																																																																																																																																						
4	WarningOutputSignal	Bit	VAR_GLOBAL	X1 00E																																																																																																																																						
5	ErrorFlag	Bit	VAR_GLOBAL	X1 00F																																																																																																																																						
6	CH1 OutputEnableDisableFlag	Bit	VAR_GLOBAL	Y1 001																																																																																																																																						
7	CH2 OutputEnableDisableFlag	Bit	VAR_GLOBAL	Y1 002																																																																																																																																						
8	CH3 OutputEnableDisableFlag	Bit	VAR_GLOBAL	Y1 003																																																																																																																																						
9	CH4 OutputEnableDisableFlag	Bit	VAR_GLOBAL	Y1 004																																																																																																																																						
10	WarningOutputClearRequest	Bit	VAR_GLOBAL	Y1 00E																																																																																																																																						
11	ErrorClearRequest	Bit	VAR_GLOBAL	Y1 00F																																																																																																																																						
12	CH1_DigInVal	Word [Signed]	VAR_GLOBAL	W1																																																																																																																																						
13	CH2_DigInVal	Word [Signed]	VAR_GLOBAL	W2																																																																																																																																						
14	CH3_DigInVal	Word [Signed]	VAR_GLOBAL	W3																																																																																																																																						
15	CH4_DigInVal	Word [Signed]	VAR_GLOBAL	W4																																																																																																																																						
16	WarningOutputUpperFlag	Word [Signed]	VAR_GLOBAL	W1 008																																																																																																																																						
17	WarningOutputLowerFlag	Word [Signed]	VAR_GLOBAL	W1 009																																																																																																																																						
18	DisconnectionDetectionFlag	Word [Signed]	VAR_GLOBAL	W1 011																																																																																																																																						
19	CH2_AlmUpLimit	Bit	VAR_GLOBAL	F0																																																																																																																																						
20	CH2_AlmLowLimit	Bit	VAR_GLOBAL	F1																																																																																																																																						
21	CH4_DisconnectDetect	Bit	VAR_GLOBAL	F2																																																																																																																																						
22	DigitWriteSig	Bit	VAR_GLOBAL	X20																																																																																																																																						
23	DADOutputSig	Bit	VAR_GLOBAL	X21																																																																																																																																						
24	WarningOutClrSig	Bit	VAR_GLOBAL	X22																																																																																																																																						
25	ErrResetSig	Bit	VAR_GLOBAL	X23																																																																																																																																						
26	Connect_FormationFlg_St1	Bit	VAR_GLOBAL	M0																																																																																																																																						

Common program

The following figure shows an example of the program to check the data link status of the remote head module (station number 1).

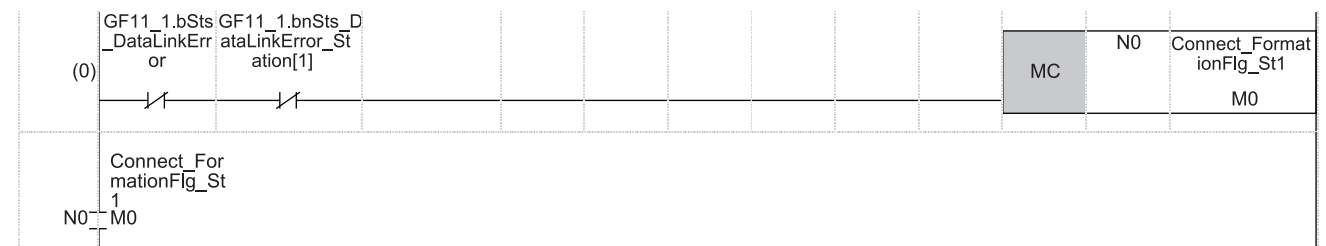

(0) Checks the data link status of the remote head module (station number 1).

Add the MCR instruction shown below to the last of the program.

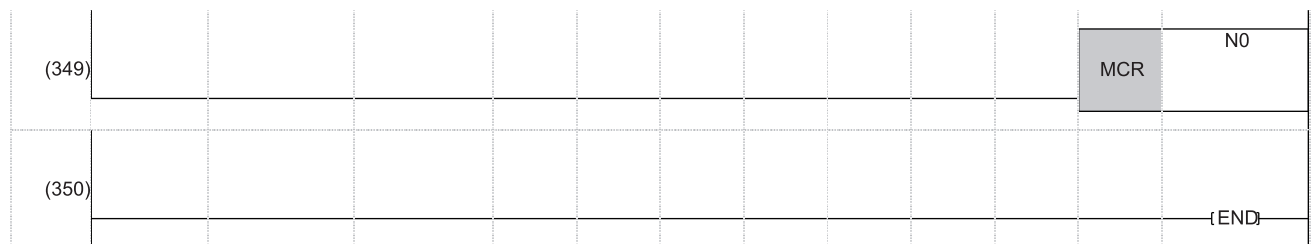

Program example 1

The following figure shows an example of the program to start D/A conversion by setting the digital values for D/A conversion (CH1 to CH4) and enabling analog output.

(32)	DigitWriteSig	MouduleREADY	ExternalPower SupplyREADY_ Flag					MOV	K10000	CH1_DigInVal
	X20	X1000	X1007							W1
								MOV	K10000	CH2_DigInVal
										W2
(107)	DAOutputSig	MouduleREADY	ExternalPower SupplyREADY_ Flag					SET		CH1OutputEnableDisableFlag
	X21	X1000	X1007							Y1001
								SET		CH2OutputEnableDisableFlag
										Y1002
(163)	DAOutputSig							SET		CH3OutputEnableDisableFlag
	X21									Y1003
								SET		CH4OutputEnableDisableFlag
										Y1004
	DAOutputSig						RST		CH1OutputEnableDisableFlag	
	X21								Y1001	
	MouduleREADY						RST		CH2OutputEnableDisableFlag	
	X1000								Y1002	
	ExternalPower SupplyREADY_ Flag						RST		CH3OutputEnableDisableFlag	
	X1007								Y1003	
							RST		CH4OutputEnableDisableFlag	
									Y1004	

(32) Sets values in CH1 Digital value to CH4 Digital value.

(107) Enables output for CH1 to CH4.

(163) Disables output for CH1 to CH4 when any of the following signals is off.

- 'D/A output enable command signal' (X21)
- 'Module READY' (X1000)
- 'External power supply READY flag' (X1007)



Program example 2

The following figure shows an example of the program to perform operations reacting to an alert (such as processing of when an alert has occurred or clearing an alert) if an alert occurs in CH2.

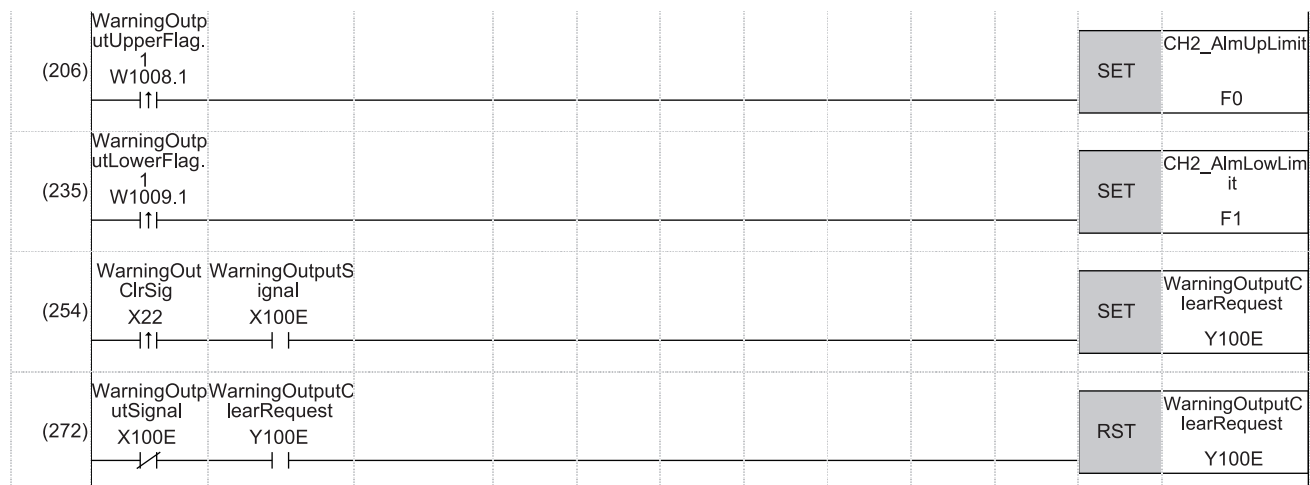

(206) Performs a processing of when an upper limit alert has occurred in CH2.

(235) Performs a processing of when a lower limit alert has occurred in CH2.

(254) Turns on 'Alert output clear request' (Y100E).

(272) Turns off 'Alert output clear request' (Y100E).

Program example 3

The following figure shows an example of the program to clear Disconnection detection flag, Error flag, and Latest error code if disconnection is detected in CH4 or an error occurs in any of the channels.

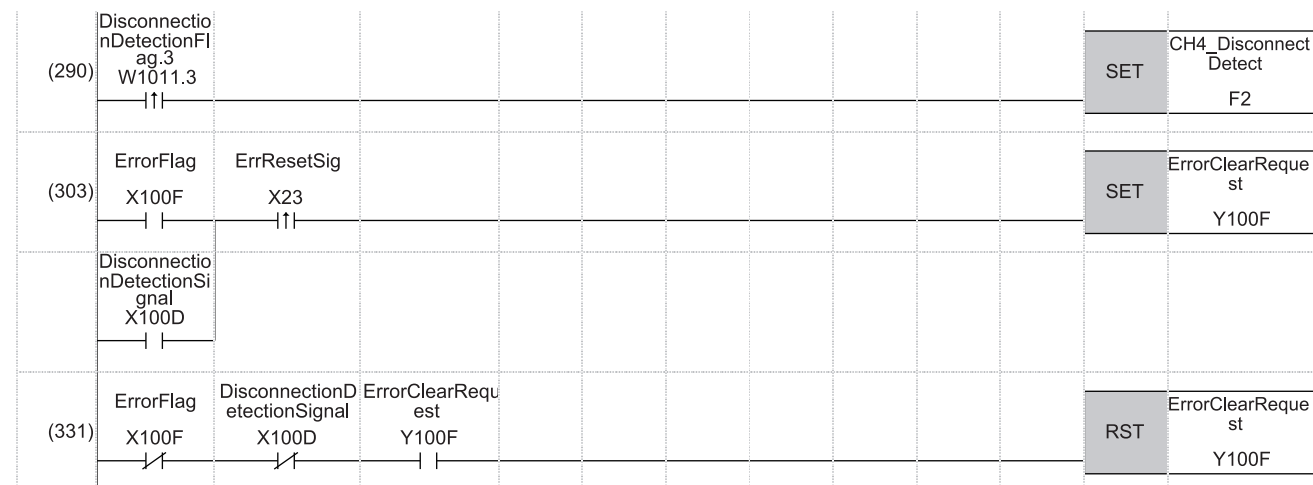

Appendix 6 Added or Changed Functions

This section describes the functions added to or changed for the D/A converter module.

Added or changed contents	Firmware version	Reference
Online module change	"02" or later	 MELSEC iQ-R Online Module Change Manual
Backing up offset/gain values	"02" or later	Page 185 Backing up offset/gain values

Backing up offset/gain values

A module-specific backup parameter is created and offset/gain values are saved.

■When an unsupported version of D/A converter modules is used

A module-specific backup parameter is not created.

INDEX

A

Alarm history	167
Alert output clear request	123
Alert Output Function	28
Alert output lower limit flag	138
Alert output signal	119
Alert output upper limit flag	137
Analog Output HOLD/CLEAR Function	20
Analog Output Test when CPU Module is in STOP Status Function	22
Application Setting	96

B

Backing up, Saving, and Restoring Offset/Gain Values	88
Basic Setting	95

C

CH1 Alert output lower limit value	157
CH1 Alert output setting	155
CH1 Alert output upper limit value	157
CH1 Constant for wave output conversion cycle	163
CH1 D/A conversion enable/disable setting	152
CH1 Decrease digital limit value	158
CH1 Factory default setting	168
CH1 HOLD/CLEAR function setting monitor	146
CH1 Increase digital limit value	158
CH1 Input value shift amount	151
CH1 Offset/gain setting mode	169
CH1 Offset/gain setting mode (range specification)	170
CH1 Output enable/disable flag	121
CH1 Output setting during wave output stop	159
CH1 Output value during wave output stop	160
CH1 Range setting	164
CH1 Range setting monitor	145
CH1 Rate control enable/disable setting	156
CH1 Scaling enable/disable setting	153
CH1 Scaling lower limit value	154
CH1 Scaling upper limit value	154
CH1 Set value check code	144
CH1 Synchronization digital value	171
CH1 User range setting	168
CH1 Wave output conversion cycle monitor	146
CH1 Wave output current address monitor	147
CH1 Wave output current digital value monitor	148
CH1 Wave output digital value out-of-range address monitor	149
CH1 Wave output start/stop request	150
CH1 Wave output status monitor	144
CH1 Wave output step action movement amount	151
CH1 Wave output warning address monitor	149
CH1 Wave pattern data points setting	162
CH1 Wave pattern output count monitor	147
CH1 Wave pattern output repetition setting	162
CH1 Wave pattern start address setting	161
Channel change completed flag	118

Channel change request	122
Condition target channel setting	143
Condition target setting	142

D

D/A conversion enable/disable function	19
D/A Output Enable/Disable Setting Function	19
Disconnection detection flag	139
Disconnection Detection Function	34
Disconnection detection signal	119

E

Error clear request	123
Error flag	120
Error history	166
Error History Function	84
Event History Function	87
External Power Supply Disconnection Detection Function	33
External power supply READY flag	115

I

Inter-module synchronization cycle	78
Inter-module synchronization function	78
Interrupt factor detection flag	137
Interrupt factor generation setting	141
Interrupt factor mask	140
Interrupt factor reset request	140
Interrupt Function	35
Interrupt setting	97

L

Latest address of alarm history	137
Latest address of error history	136
Latest alarm code	136
Latest error code	136

M

Mode switching setting	143
Module Label	111
Module READY	114

N

Normal output mode	16
------------------------------	----

O

Offset/gain adjustment value specification	169
Offset/gain setting mode status flag	117
Operating condition setting completed flag	116
Operating condition setting request	121
Output mode	139
Output setting during synchronous Error	172

P

PARAMETER SETTING 95

Q

Q compatible mode function 94

R

Range switching function 18
Rate control function 30
Refresh settings 98
Restrictions and precautions on the wave output function
. 40

S

Save data type setting 167
Scaling Function 23
Set value change completed flag 118
Shift Function 26
Step action wave output request 141
Synchronization digital value 78
Synchronization status monitor 172

U

User range write request 122

V

Value change request 122

W

Wave data 40
Wave data registry area 173
Wave Output Function 38
Wave output mode 16
Wave output step action function 70



REVISIONS

*The manual number is given on the bottom left of the back cover.

Print data	*Manual number	Revision
June 2014	SH(NA)-081237ENG-A	First edition
January 2015	SH(NA)-081237ENG-B	■Added function Online module change ■Added or modified parts RELEVANT MANUALS, Section 1.18, 3.1, 3.4, Appendix 3, 5
August 2015	SH(NA)-081237ENG-C	■Added or modified parts SAFETY PRECAUTIONS, Section 1.6, 1.14, 1.16, 1.17, 3.4, 3.5, Appendix 1 to 3
May 2016	SH(NA)-081237ENG-D	■Added or modified parts SAFETY PRECAUTIONS, TERMS, Chapter 1, Section 1.5, Section 1.6, Section 1.10, Section 1.14, Section 2.4, Section 3.3, Appendix 5
December 2018	SH(NA)-081237ENG-E	■Added or modified parts SAFETY PRECAUTIONS, CONDITIONS OF USE FOR THE PRODUCT, INTRODUCTION, RELEVANT MANUALS, Section 1.2, 1.5, 1.15, 1.18, 2.4, Appendix 3, 4

Japanese manual number: SH-081236-E

This manual confers no industrial property rights or any rights of any other kind, nor does it confer any patent licenses. Mitsubishi Electric Corporation cannot be held responsible for any problems involving industrial property rights which may occur as a result of using the contents noted in this manual.

© 2014 MITSUBISHI ELECTRIC CORPORATION

WARRANTY

Please confirm the following product warranty details before using this product.

1. Gratis Warranty Term and Gratis Warranty Range

If any faults or defects (hereinafter "Failure") found to be the responsibility of Mitsubishi occurs during use of the product within the gratis warranty term, the product shall be repaired at no cost via the sales representative or Mitsubishi Service Company.

However, if repairs are required onsite at domestic or overseas location, expenses to send an engineer will be solely at the customer's discretion. Mitsubishi shall not be held responsible for any re-commissioning, maintenance, or testing on-site that involves replacement of the failed module.

[Gratis Warranty Term]

The gratis warranty term of the product shall be for one year after the date of purchase or delivery to a designated place. Note that after manufacture and shipment from Mitsubishi, the maximum distribution period shall be six (6) months, and the longest gratis warranty term after manufacturing shall be eighteen (18) months. The gratis warranty term of repair parts shall not exceed the gratis warranty term before repairs.

[Gratis Warranty Range]

- (1) The range shall be limited to normal use within the usage state, usage methods and usage environment, etc., which follow the conditions and precautions, etc., given in the instruction manual, user's manual and caution labels on the product.
- (2) Even within the gratis warranty term, repairs shall be charged for in the following cases.
 1. Failure occurring from inappropriate storage or handling, carelessness or negligence by the user. Failure caused by the user's hardware or software design.
 2. Failure caused by unapproved modifications, etc., to the product by the user.
 3. When the Mitsubishi product is assembled into a user's device, Failure that could have been avoided if functions or structures, judged as necessary in the legal safety measures the user's device is subject to or as necessary by industry standards, had been provided.
 4. Failure that could have been avoided if consumable parts (battery, backlight, fuse, etc.) designated in the instruction manual had been correctly serviced or replaced.
 5. Failure caused by external irresistible forces such as fires or abnormal voltages, and Failure caused by force majeure such as earthquakes, lightning, wind and water damage.
 6. Failure caused by reasons unpredictable by scientific technology standards at time of shipment from Mitsubishi.
 7. Any other failure found not to be the responsibility of Mitsubishi or that admitted not to be so by the user.

2. Onerous repair term after discontinuation of production

- (1) Mitsubishi shall accept onerous product repairs for seven (7) years after production of the product is discontinued. Discontinuation of production shall be notified with Mitsubishi Technical Bulletins, etc.
- (2) Product supply (including repair parts) is not available after production is discontinued.

3. Overseas service

Overseas, repairs shall be accepted by Mitsubishi's local overseas FA Center. Note that the repair conditions at each FA Center may differ.

4. Exclusion of loss in opportunity and secondary loss from warranty liability

Regardless of the gratis warranty term, Mitsubishi shall not be liable for compensation to:

- (1) Damages caused by any cause found not to be the responsibility of Mitsubishi.
- (2) Loss in opportunity, lost profits incurred to the user by Failures of Mitsubishi products.
- (3) Special damages and secondary damages whether foreseeable or not, compensation for accidents, and compensation for damages to products other than Mitsubishi products.
- (4) Replacement by the user, maintenance of on-site equipment, start-up test run and other tasks.

5. Changes in product specifications

The specifications given in the catalogs, manuals or technical documents are subject to change without prior notice.

TRADEMARK

The company names, system names and product names mentioned in this manual are either registered trademarks or trademarks of their respective companies.

In some cases, trademark symbols such as [™] or [®] are not specified in this manual.

SH(NA)-081237ENG-E(1812)MEE

MODEL: R-DA-U-OU-E

MODEL CODE: 13JX13

mitsubishi electric corporation

HEAD OFFICE : TOKYO BUILDING, 2-7-3 MARUNOUCHI, CHIYODA-KU, TOKYO 100-8310, JAPAN
NAGOYA WORKS : 1-14, YADA-MINAMI 5-CHOME, HIGASHI-KU, NAGOYA, JAPAN

When exported from Japan, this manual does not require application to the
Ministry of Economy, Trade and Industry for service transaction permission.

Specifications subject to change without notice.